

MOI6-REC
(MOI6-REC-P4-C8 Shown)

Ordering Information	Description:
Slab Thickness: Single Rec: <input type="checkbox"/> 15A <input type="checkbox"/> 20A Duplex Rec: <input type="checkbox"/> 15A <input type="checkbox"/> 20A Cover Type:	 LEW ELECTRIC FITTINGS COMPANY 877-537-2019 www.lewelectric.com
Proprietary and Confidential The information contained in this drawing is the sole property of NOCOM. Any reproduction in part or as a whole without the written permission of NOCOM is prohibited.	
	DWG. No. MOI6-REC

MOI6 Various Configurations

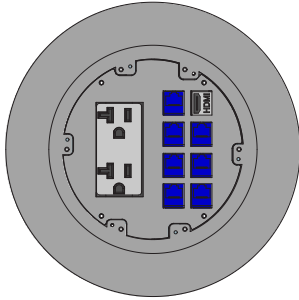

MOI6-REC-DP-C8

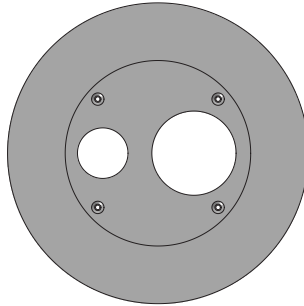

MOI6-REC-SYS-COMM

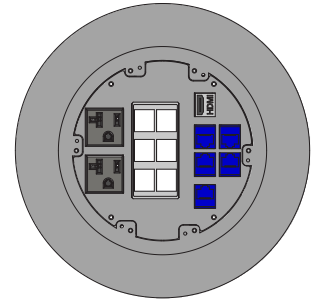

MOI6-REC-P2-AV-C6

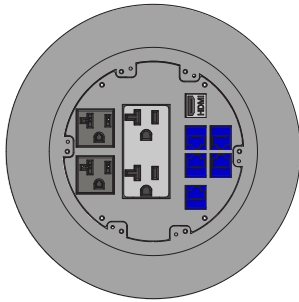

MOI6-REC-P2-DP-C6

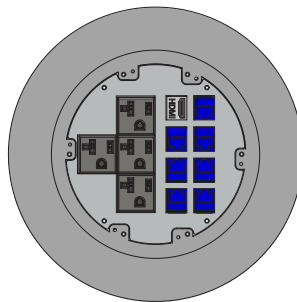

MOI6-REC-P4-C8

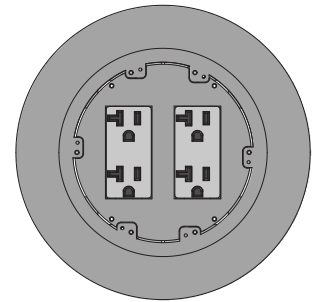

MOI6-REC-DP2

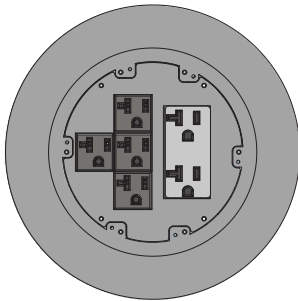

MOI6-REC-P4-DP

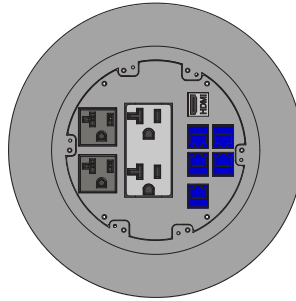

MOI6-REC-P2-DPusb-C6

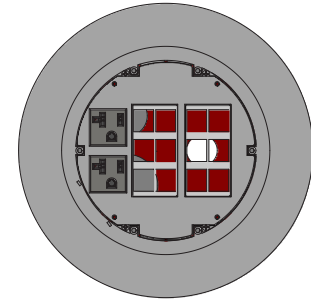

MOI6-REC-P2-AV2

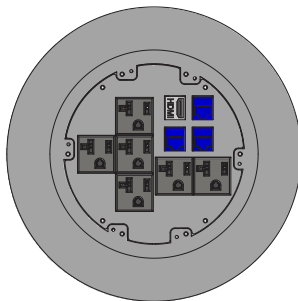

MOI6-REC-P6-C4

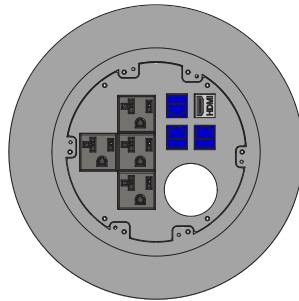

MOI6-REC-P4-C4-AV1.5

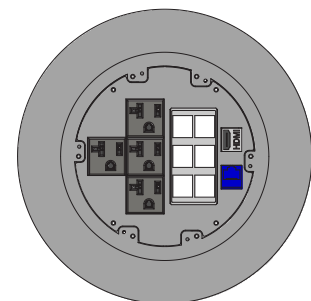

MOI6-REC-P4-AV-C2

Ordering Information	Description:
Slab Thickness:	 LEW ELECTRIC FITTINGS COMPANY 877-537-2019 www.lewelectric.com
Single Rec: <input type="checkbox"/> 15A <input type="checkbox"/> 20A	
Duplex Rec: <input type="checkbox"/> 15A <input type="checkbox"/> 20A	
Cover Type:	
Proprietary and Confidential The information contained in this drawing is the sole property of NOCOM. Any reproduction in part or as a whole without the written permission of NOCOM is prohibited.	DWG. No. MOI6-REC

Articulated Hinge Cover with Cable Exit Door (AHC-CED)

Cover Fully Closed

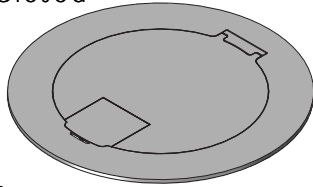

Cover CED Open

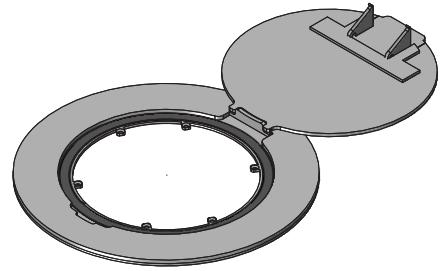
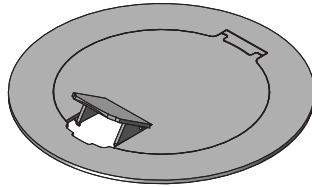

Cover Fully Open

Cover Finishes

Standard = Brushed Stainless Steel

*Custom = Brushed Brass

or

Black Matte

*Additional cost may apply

*Other colours/finishes available upon request

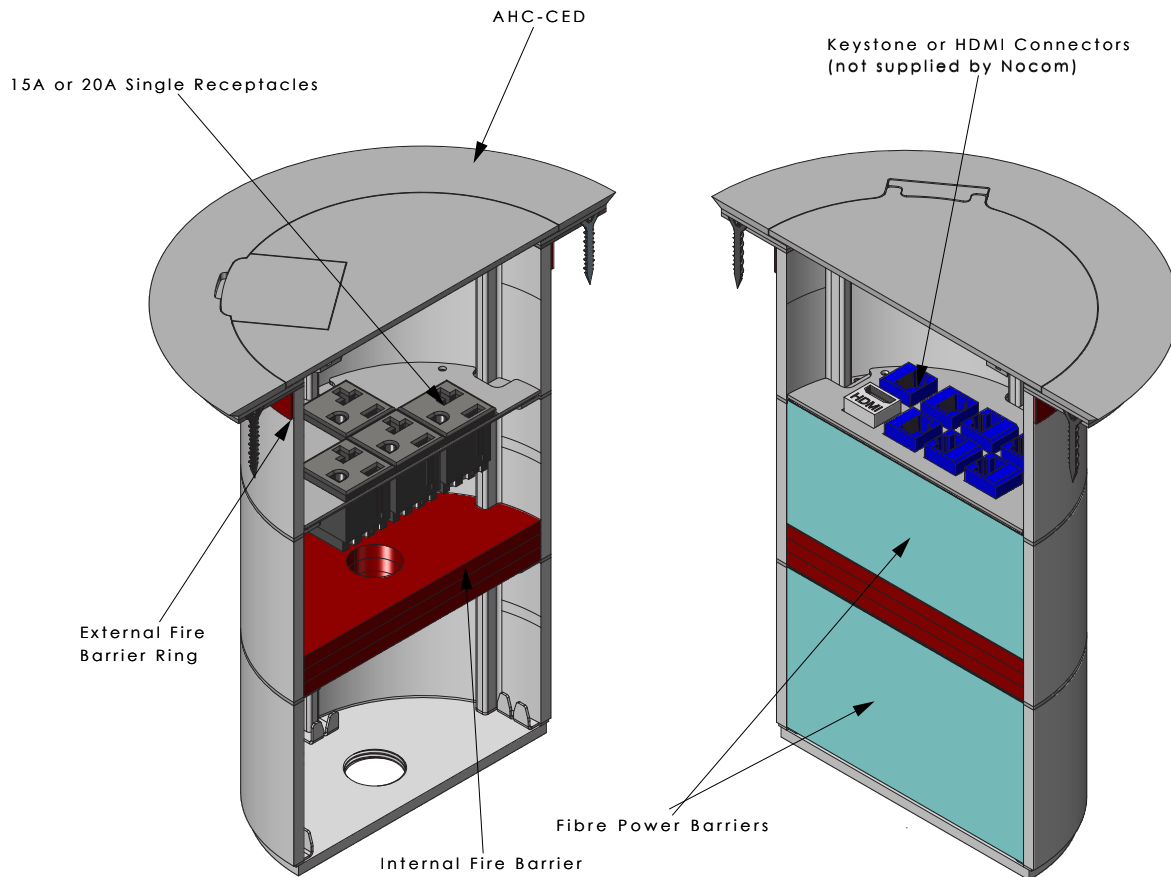

(MOI6-REC-P4-C8 Shown)

Ordering Information	Description:
Slab Thickness: Single Rec: <input type="checkbox"/> 15A <input type="checkbox"/> 20A Duplex Rec: <input type="checkbox"/> 15A <input type="checkbox"/> 20A Cover Type: Proprietary and Confidential The information contained in this drawing is the sole property of NOCOM. Any reproduction in part or as a whole without the written permission of NOCOM is prohibited.	 LEW ELECTRIC FITTINGS COMPANY 877-537-2019 www.lewelectric.com DWG. No. MOI6-REC

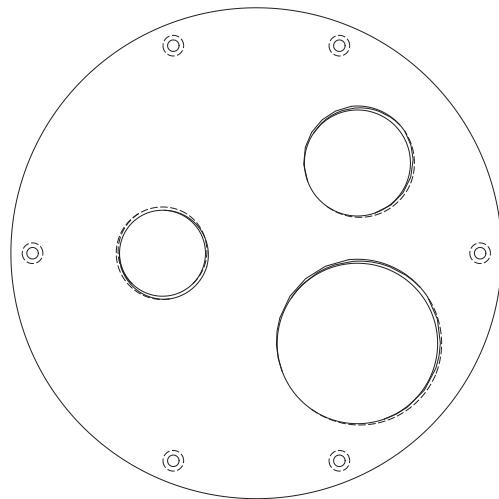
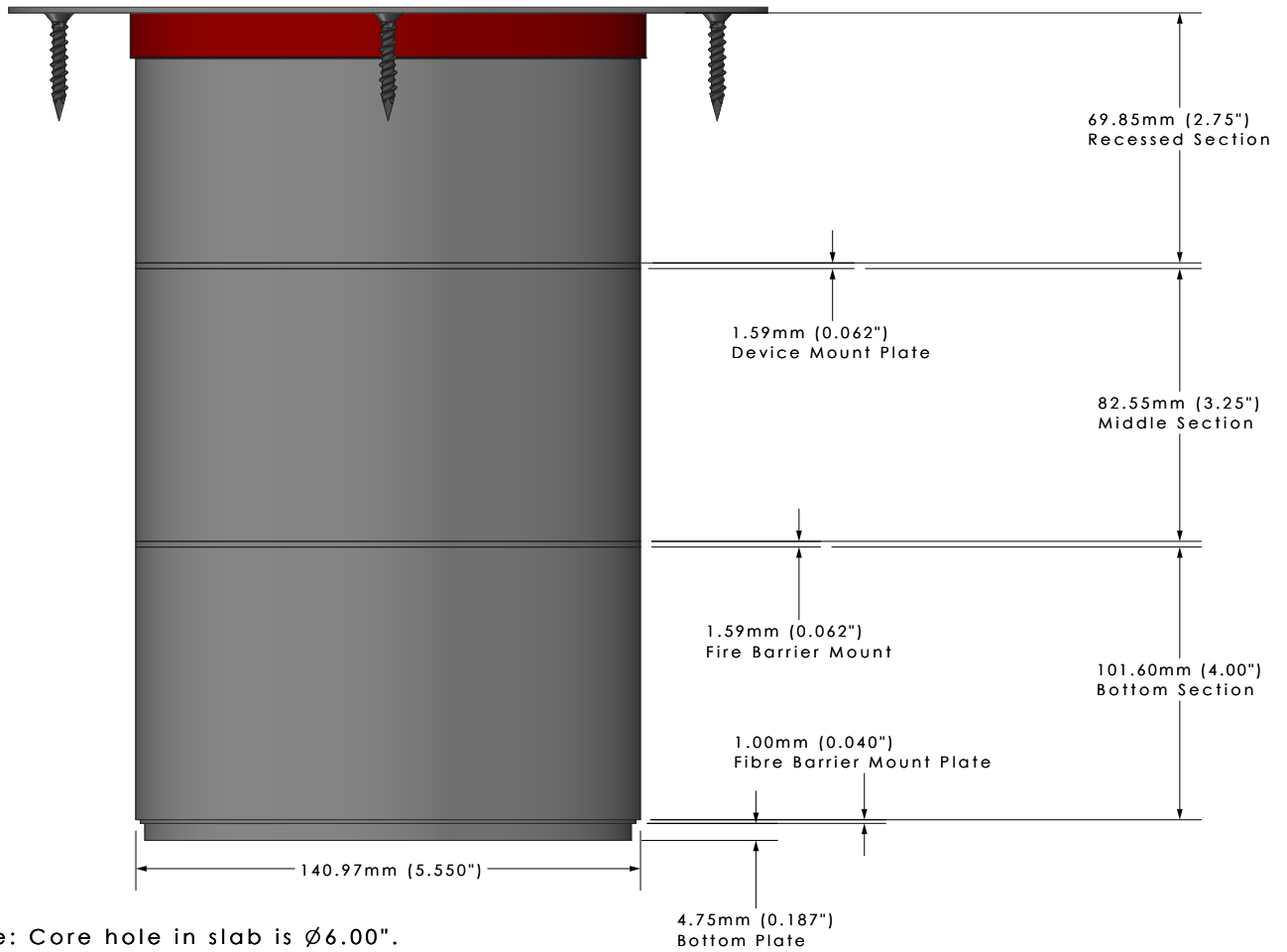

Removable Bottom Plate

- NPS 0.750"
- NPS 1.000"
- NPS 1.500"

Ordering Information	Description:
Slab Thickness: Single Rec: <input type="checkbox"/> 15A <input type="checkbox"/> 20A Duplex Rec: <input type="checkbox"/> 15A <input type="checkbox"/> 20A Cover Type: Proprietary and Confidential The information contained in this drawing is the sole property of NOCOM. Any reproduction in part or as a whole without the written permission of NOCOM is prohibited.	 LEW ELECTRIC FITTINGS COMPANY 877-537-2019 www.lewelectric.com DWG. No. MOI6-REC