



Providing the *power*
to **design** your **vision**



Catalog #1024

Log on to
www.lewelectric.com
for complete line catalog and specifications
877-537-2019

Table of Contents

Countertop

PUR Series	3-11
pointpod	12
PDAS	13
PUPP-CT Series	14-17

Residential Floor Boxes

PUPP Series	18-19
RCFB Series	20
RB Series	21
Plastic Box Series	22-25
Resi Poke-Through	26-27
RRP Series	28-29
SWB Series	30-31
812 Series	32-33

Outdoor Boxes 34-35

PVC Floor Boxes

PVC Box and Accessories	36
Non-Metallic Covers	36
Metal Covers	37

Commercial Floor Boxes

Access Series	38-39
Rectangular Boxes	40-43
Round Boxes	44-45
In-Slab	46-47
Nozzles	48

Replacement Plugs 49

Poke-Throughs 50-55



LEW ELECTRIC FITTINGS COMPANY
 »»» 4 GENERATIONS FAMILY OWNED AND OPERATED «««

Low Electric is a fourth generation family owned and operated company. Our founder, Jake Lewin, was an electrical engineer and inventor. He designed and produced numerous patented products, the first being a slide connector for couplers, designed in 1930. He was an industry leader in creating the first floor boxes on the market and some of his designs are still used today. "LEW" was passed on to Jake's wife Lilly upon his death and today is owned and managed by Lilly's grandchildren and great grandchildren.



PUR Countertop Boxes



New Design

- 1 Reduced cover footprint on counter
- 2 New Qi Wireless Charging cover options
5 colors: Black Tempered Glass, Black Resin, Stainless Tempered Glass, Stainless Resin, White Resin
- 3 Bluetooth speaker option
- 4 Hard Wired to meet new 2023 NEC codes
- 5 Smaller locking ring reduces under cabinet space needed

FEATURES AND BENEFITS (pages 3-11)

- *Qi wireless charging option* (5 cover options)
- *Bluetooth speaker option*
- *Includes 5 foot of wiring* to use from junction box in cabinet into the unit
- For installation on *counters, desk tops or under cabinets*
- *For use in Kitchens, offices, labs, etc.*
- *ETL listed* to UL standard 498
- Not to be used in outdoor "wet" locations. Indoor use only.

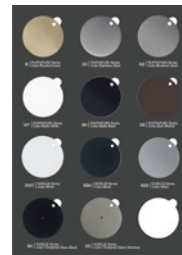
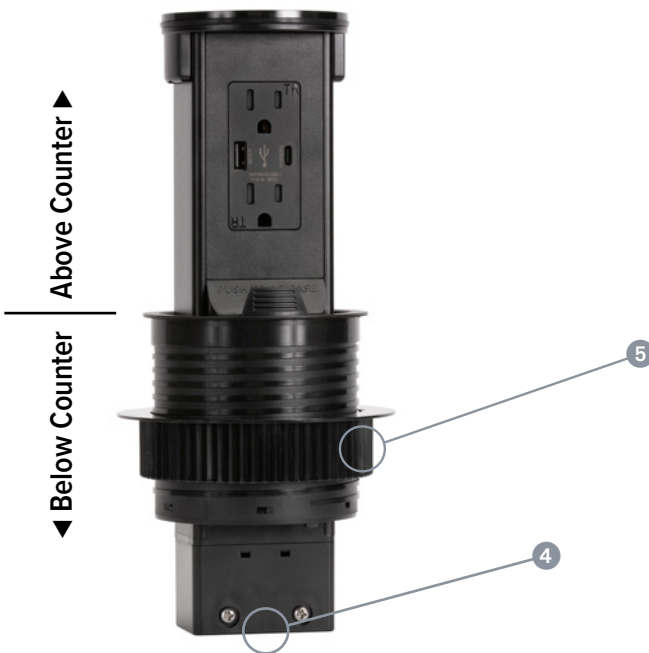

CATALOG #
CT-CC: Color Chip Sample Book for PUR series (pp 3-11) and PUFFP-CT (pp 14-17)



Conforms to UL standard 498 and 943 (GFI)
 Certified to CSA STD.C22.2.; No. 42-10;
 LEW ELECTRIC FITTINGS CO.

PUR Limited Warranty: 2 years from date of purchase

PUR Countertop Boxes – *Wireless Charge (15W)*

» PUR20GACBTQD-XX (GFI, USB Type A & C, Bluetooth Speaker)



PUR20GACBTQD-BK

» **15W Wireless Charging** Black Tempered Glass Cover



PUR20GACBTQD-RBK

» **15W Wireless Charging** Black Resin Cover



PUR20GACBTQD-SS

» **15W Wireless Charging** Stainless Tempered Glass Cover



PUR20GACBTQD-RSS

» **15W Wireless Charging** Stainless Resin Cover



PUR20GACBTQD-RWT

» **15W Wireless Charging** White Resin Cover

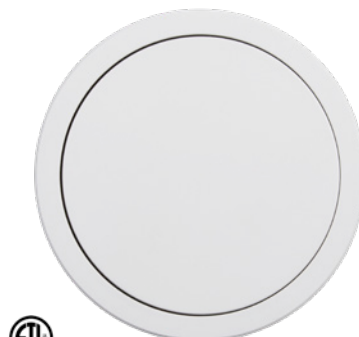

NEC 2023 COMPLIANT

DESCRIPTION		
Pop up countertop assembly with one 20 AMP (TR) GFI receptacle, 2 USB ports (Type A [30W] & C [30W]) and 3W Bluetooth Speaker		
COVER DIAMETER	IN-USE HEIGHT	UNDER COUNTER DEPTH WHEN CLOSED
4"	9.1"	14.5"

PUR Countertop Boxes – Wireless Charge (15W)

» PUR20GACQD-XX (GFI, USB Type A & C)



NEC 2023 COMPLIANT

DESCRIPTION		
Pop up countertop assembly with one 20 AMP (TR) GFI receptacle and 2 USB ports (Type A [30W] & C [30W])		
COVER DIAMETER	IN-USE HEIGHT	UNDER COUNTER DEPTH WHEN CLOSED
4"	7.13"	12.5"

PUR20GACQD-BK

» 15W Wireless Charging Black Tempered Glass Cover

PUR20GACQD-RBK

» 15W Wireless Charging Black Resin Cover

PUR20GACQD-SS

» 15W Wireless Charging Stainless Tempered Glass Cover

PUR20GACQD-RSS

» 15W Wireless Charging Stainless Resin Cover

PUR20GACQD-RWT

» 15W Wireless Charging White Resin Cover



PUR Countertop Boxes – Wireless Charge (15W)

>> PUR15ACQD-XX (Duplex power, USB Type A & C)

NEC 2023 COMPLIANT

DESCRIPTION		
Pop up countertop assembly with one 15 AMP (TR) duplex power/ 2 USB (Type A & C) receptacle. <i>USB charging ports: 27W max (A) & 30W max (C) when charging individually, or total 27W max when charging simultaneously [12W max (A) & 15W max (C)].</i>		
COVER DIAMETER	IN-USE HEIGHT	UNDER COUNTER DEPTH WHEN CLOSED
4"	5.17"	8.5"



PUR15ACQD-BK

>> **15W Wireless Charging** Black
Tempered Glass Cover



PUR15ACQD-RBK

>> **15W Wireless Charging** Black
Resin Cover



PUR15ACQD-RSS

>> **15W Wireless Charging** Stainless
Resin Cover

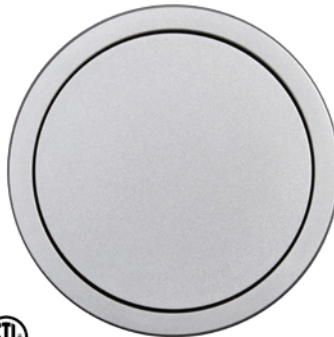

PUR15ACQD-RWT

>> **15W Wireless Charging** White
Resin Cover

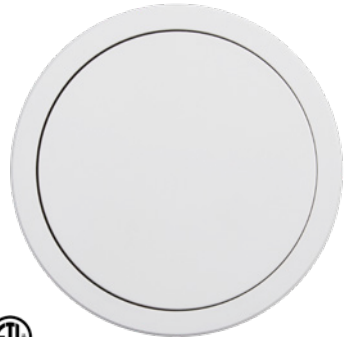

PUR **Countertop Boxes**

» PUR20GACD-XX (GFI, USB Type A & C)



NEC 2023 COMPLIANT

DESCRIPTION		
Pop up countertop assembly with one 20 AMP (TR) GFI receptacle and 2 USB ports (Type A [30W] & C [30W])		
COVER DIAMETER	IN-USE HEIGHT	UNDER COUNTER DEPTH WHEN CLOSED
4"	7.13"	12.5"

PUR20GACD-BK	PUR20GACD-SS	PUR20GACD-WT
» Matte Black Metal Cover	» Stainless Steel Metal Cover	» Matte White Metal Cover
		
		

PUR **Countertop Boxes**

» PUR20GACBTD-XX (GFI, USB Type A & C, Bluetooth Speaker)



NEC 2023 COMPLIANT

DESCRIPTION		
Pop up countertop assembly with one 20 AMP (TR) GFI receptacle, 2 USB ports (Type A [30W] & C [30W]) & 3W Bluetooth Speaker		
COVER DIAMETER	IN-USE HEIGHT	UNDER COUNTER DEPTH WHEN CLOSED
4"	9.1"	14.5"

PUR20GACBTD-BK	PUR20GACBTD-SS	PUR20GACBTD-WT
» Matte Black Metal Cover	» Stainless Steel Metal Cover	» Matte White Metal Cover
		
		

PUR Countertop Boxes

>> PUR20ACD-XX (Duplex power, USB Type A & C)

NEC 2023 COMPLIANT



DESCRIPTION		
Pop up countertop assembly with one 20 AMP (TR) duplex power/ 2 USB (Type A & C) receptacle. <i>USB charging ports: 27W max (A) & 30W max (C) when charging individually, or total 27W max when charging simultaneously [12W max (A) & 15W max (C)].</i>		
COVER DIAMETER	IN-USE HEIGHT	UNDER COUNTER DEPTH WHEN CLOSED
4"	5.17"	8.5"

PUR20ACD-B

>> Brushed Brass Metal Cover



PUR20ACD-BK

>> Matte Black Metal Cover



PUR20ACD-DB

>> Dark Bronze Metal Cover



PUR20ACD-NS

>> Brushed Nickel Silver Metal Cover



PUR20ACD-SS

>> Stainless Steel Metal Cover



PUR20ACD-WT

>> Matte White Metal Cover

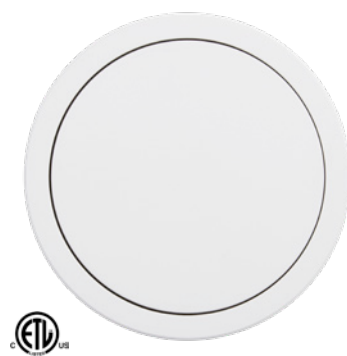

PUR Countertop Boxes

» PUR20GD-XX (GFI)

NEC 2023 COMPLIANT



DESCRIPTION		
Pop up countertop assembly with one 20 AMP (TR) GFI receptacle		
COVER DIAMETER	IN-USE HEIGHT	UNDER COUNTER DEPTH WHEN CLOSED
4"	5.17"	8.5"

PUR20GD-B	PUR20GD-BK
» Brushed Brass Metal Cover	» Matte Black Metal Cover
	
	
PUR20GD-DB	PUR20GD-NS
» Dark Bronze Metal Cover	» Brushed Nickel Silver Metal Cover
	
	
PUR20GD-SS	PUR20GD-WT
» Stainless Steel Metal Cover	» Matte White Metal Cover
	
	



PUR Countertop Boxes

>> PUR20AC2PD-XX (Two Duplex power, USB Type A & C)

NEC 2023 COMPLIANT

DESCRIPTION		
Pop up countertop assembly with two 20 AMP (TR) duplex power/ 2 USB (Type A & C) receptacles. <i>USB charging ports: 27W max (A) & 30W max (C) when charging individually, or total 27W max when charging simultaneously [12W max (A) & 15W max (C)].</i>		
COVER DIAMETER	IN-USE HEIGHT	UNDER COUNTER DEPTH WHEN CLOSED
4"	10.5"	16"



PUR20AC2PD-BK	PUR20AC2PD-SS	PUR20AC2PD-WT
>> Matte Black Metal Cover	>> Stainless Steel Metal Cover	>> Matte White Metal Cover
		

PUR Countertop Boxes

>> PUR20DSD-XX (Decora)

NEC 2023 COMPLIANT

DESCRIPTION		
Pop up countertop assembly with one 20 AMP (TR) Decora receptacle		
COVER DIAMETER	IN-USE HEIGHT	UNDER COUNTER DEPTH WHEN CLOSED
4"	5.17"	8.5"



PUR20DSD-BK	PUR20DSD-SS	PUR20DSD-WT
>> Matte Black Metal Cover	>> Stainless Steel Metal Cover	>> Matte White Metal Cover
		

PUR Under Cabinet Pop Down Receptacles



»» UCPDR20ACD-SS (Duplex power, USB Type A & C)

DESCRIPTION		
Stainless Steel metal cover: Under Cabinet Pop Down Assembly with one 20 AMP (TR) duplex power/2 USB (Type A & C) receptacle. <i>USB charging ports: 27W max (A) & 30W max (C) when charging individually, or total 27W max when charging simultaneously [12W max (A) & 15W max (C)].</i>		
COVER DIAMETER	IN-USE HEIGHT	IN CABINET HEIGHT WHEN CLOSED
4"	5.17"	13.5"



»» UCPDR20GACD-SS (GFI, USB Type A & C)

DESCRIPTION		
Stainless Steel metal cover: Under Cabinet Pop Down with one 20 AMP (TR) GFI receptacle and 2 USB ports (TYPE A & C)		
COVER DIAMETER	IN-USE HEIGHT	IN CABINET HEIGHT WHEN CLOSED
4"	7.14"	15.5"



»» UCPDR20GD-SS (GFI)

DESCRIPTION		
Stainless Steel metal cover: Under Cabinet Pop Down with one 20 AMP (TR) GFI receptacle		
COVER DIAMETER	IN-USE HEIGHT	IN CABINET HEIGHT WHEN CLOSED
4"	5.17"	13.5"



For 2014 NEC code and below

pointpod **Countertop Box**

>> Duplex power, 3 USB Type A & C)

>> PPCV815B

DESCRIPTION		
Automated Kitchen Countertop Pop Up With 15A (TR) Duplex Power/3USB (AC) Black Receptacle and Black Bezel		
COVER DIAMETER	IN-USE HEIGHT	UNDER COUNTER DEPTH WHEN CLOSED
4"	7"	18"
PPCTCB: Top Cup replacement part (Black)		



PPCV815 <<<

DESCRIPTION		
Automated Kitchen Countertop Pop Up With 15A (TR) Duplex Power/3USB (AC) White Receptacle and Silver Bezel		
COVER DIAMETER	IN-USE HEIGHT	UNDER COUNTER DEPTH WHEN CLOSED
4"	7"	18"
PPCTS: Top Cup replacement part (Silver)		



Conforms to UL standard 962A
Certified to CSA standard C22.2 #C22.2
US PATENT# US 10777985B2

Intertek
5025917

pointpod Limited Warranty:
2 years from date of purchase



FEATURES AND BENEFITS

- **One touch automation** raises the unit when power is needed. A second touch closes the unit and hides it under the countertop
- **Countertop material installs in lid** to fully integrate into kitchen design
- **Receptacle:** 15AMP with 3 USB charging ports (1 type A [12W] and 2 type C [15W])
- Available in **stainless trim** or **black trim**

PDAS Garbage Disposal Air Switch





» PDAS-XX







DESCRIPTION		
Garbage Disposal Air Switch Kit (Complete)		
BUTTON DIAMETER	BUTTON HEIGHT	OVERALL HEIGHT (INCLUDING BUTTON AND AIR HOSE NUT)
1.81"	.31"	3.5"





PDAS-B	PDAS-BK
» Brass	» Black
	
	

PDAS-BS	PDAS-CH
» Black Stainless	» Chrome
	
	

PDAS-DB	PDAS-G
» Dark Bronze	» Graphite
	
	

PDAS-NP	PDAS-SS
» Nickel	» Stainless
	
	

PDAS-WT	
» White	
	



Conforms to UL standard 61058-1
 Certified to CSA standard C22.2 #61058-1

FEATURES AND BENEFITS

- Available in 9 finishes
- Includes *button, controller, 10' air tubing*
- Provides on/off function *for up to 1HP disposal*

PUFP Countertop Boxes – GFI Receptacle



PUFP-CT-B-PB

New Design Features

- 1 Solid color metallic oval open/close button
- 2 Contoured side panels for smoother motion when opening/closing
- 3 Easy to install plastic box and locking ring

NEC 2023 COMPLIANT

FEATURES AND BENEFITS (pages 14-15)

- Intertek **IP44 RATED** BOX
- **Conforms to UL** standard 498 and 943 (GFI)
Certified to CSA STD.C22.2.; No. 42-10
- **Receptacles:** GFI – UL Listed E473428
Weather resistant (WR) outlet
- **Pops up** when in use
- **Hides in the box** when not in use
- For **residential or commercial** applications
- **Scrub water tight** construction
- All PUFF styles supplied with **tamper resistant** receptacles



DESCRIPTION
Poly-Box and Locking Ring for PUFF series covers (included)

CATALOG #
PUFP-PB (Poly-box and Locking Ring)
PUFP-PB-LR (Replacement Locking Ring only)

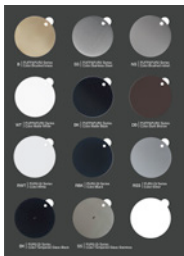

CATALOG #
CT-CC: Color Chip Sample Book for PUFF-CT (pp 14-17) and PUR series (pp 3-11)



Conforms to UL standard 498 and 943 (GFI)
Certified to CSA STD.C22.2.; No. 42-10;
LEW ELECTRIC FITTINGS CO.

PUFP-CT Limited Warranty: 2 years from date of purchase

PUPF Countertop Boxes – GFI Receptacle

» PUPF-CT-XX-PB

NEC 2023 COMPLIANT



DESCRIPTION			
Pop up countertop plate assembly, with 20 AMP (TR) GFI receptacle (includes PUPF-PB box)			
PLATE WIDTH	PLATE DEPTH	PLATE HEIGHT (Open)	BOX DIMENSIONS
4 11/16"	4 11/16"	3 1/2"	4 1/8" W x 4 1/8" D x 3 1/8" H



PUPF-CT-B-PB

» Brushed Brass Metal Cover
 White Receptacle

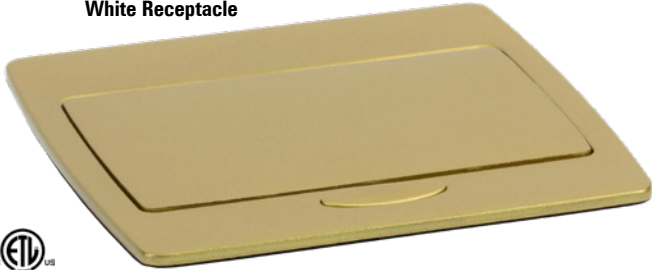

PUPF-CT-BK-PB

» Matte Black Metal Cover
 Grey Receptacle



PUPF-CT-DB-PB

» Dark Bronze Metal Cover
 Grey Receptacle



PUPF-CT-NS-PB

» Brushed Nickel Silver Metal Cover
 Grey Receptacle

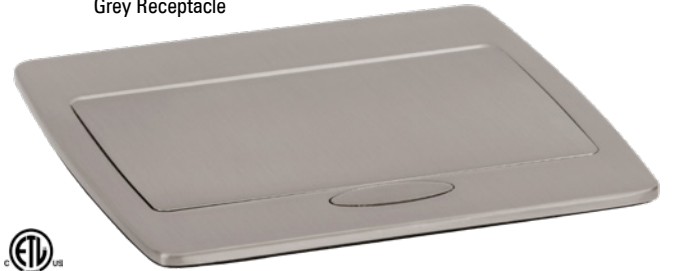

PUPF-CT-SS-PB

» Stainless Steel Metal Cover
 Grey Receptacle



PUPF-CT-WT-PB

» Matte White Metal Cover
 Grey Receptacle



PUFP Countertop Boxes – USB Receptacle



PUFP-CT-DB-AC-PB

New Design Features

- 1 Solid color metallic oval open/close button
- 2 Contoured side panels for smoother motion when opening/closing
- 3 USB charging ports: 27W max (A) & 30W max (C) when charging individually, or total 27W max when charging simultaneously [12W max (A) & 15W max (C)].
- 4 Easy to install plastic box and locking ring

NEC 2023 COMPLIANT

FEATURES AND BENEFITS (pages 16-17)

- Intertek **IP44 RATED** BOX
- **Conforms to UL** UL standard 498 (2USB)
Certified to CSA STD.C22.2.; No. 42-10
- **Receptacles:** USB – UL Listed E491706
- **Pops up** when in use
- **Hides in the box** when not in use
- For **residential or commercial** applications
- **Scrub water tight** construction
- All PUFF styles supplied with **tamper resistant** receptacles

DESCRIPTION
Poly-Box and Locking Ring for PUFF series covers (included)

CATALOG #
PUFP-PB (Poly-box and Locking Ring)
PUFP-PB-LR (Replacement Locking Ring only)



CATALOG #
CT-CC: Color Chip Sample Book for PUFF-CT (pp 14-17) and PUR series (pp 3-11)

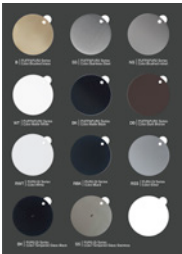

Conforms to UL standard 498 (2USB)
Certified to CSA STD.C22.2.; No. 42-10;
LEW ELECTRIC FITTINGS CO.

PUFP-CT Limited Warranty: 2 years from date of purchase

PUFP **Countertop Boxes** – USB Receptacle

» PUF-P-CT-XX-AC-PB

NEC 2023 COMPLIANT

DESCRIPTION

Pop up countertop plate assembly, with 20 AMP (TR) duplex power/ 2USB (AC) receptacle (includes PUF-P-B box). USB charging ports: 27W max (A) & 30W max (C) when charging individually, or total 27W max when charging simultaneously [12W max (A) & 15W max (C)].

PLATE WIDTH	PLATE DEPTH	PLATE HEIGHT (Open)	BOX DIMENSIONS
4 11/16"	4 11/16"	3 1/2"	4 1/8" W x 4 1/8" D x 3 1/8" H



PUFP-CT-B-AC-PB

» Brushed Brass Metal Cover
 White Receptacle

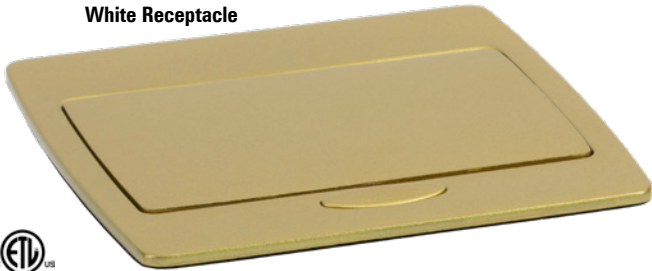

PUFP-CT-BK-AC-PB

» Matte Black Metal Cover
 Grey Receptacle

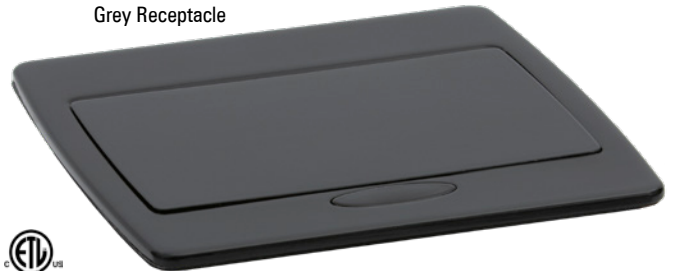

PUFP-CT-DB-AC-PB

» Dark Bronze Metal Cover
 Grey Receptacle

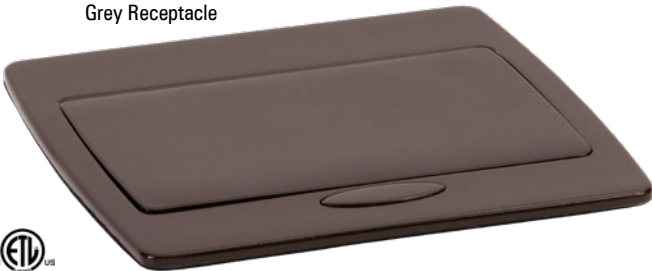

PUFP-CT-NS-AC-PB

» Brushed Nickel Silver Metal Cover
 Grey Receptacle

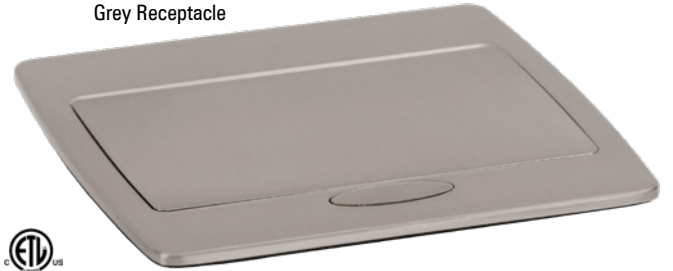

PUFP-CT-SS-AC-PB

» Stainless Steel Metal Cover
 Grey Receptacle



PUFP-CT-WT-AC-PB

» Matte White Metal Cover
 Grey Receptacle



PUFPP Square Floor Boxes

CATALOG #	DESCRIPTION
PUFPP-SQ-BR	Brass pop up floor plate assembly, with 15 AMP (TR) duplex power receptacle
PUFPP-SQ-BR-GFI	Brass pop up floor plate assembly, with 20 AMP (TR) GFI receptacle
PUFPP-SQ-BR-USB	Brass pop up floor plate assembly, with 15 AMP (TR) duplex power/ 2USB receptacle
PUFPP-SQ-DB	Dark Bronze pop up floor plate assembly, with 15 AMP (TR) duplex power receptacle
PUFPP-SQ-DB-GFI	Dark Bronze pop up floor plate assembly, with 20 AMP (TR) GFI receptacle
PUFPP-SQ-DB-USB	Dark Bronze pop up floor plate assembly, with 15 AMP (TR) duplex power/ 2USB receptacle
PUFPP-SQ-SS	Stainless Steel pop up floor plate assembly, with 15 AMP (TR) duplex power receptacle
PUFPP-SQ-SS-GFI	Stainless Steel pop up floor plate assembly, with 20 AMP (TR) GFI receptacle
PUFPP-SQ-SS-USB	Stainless Steel pop up floor plate assembly, with 15 AMP (TR) duplex power/ 2USB receptacle
PUFPP-SQ-SS-20A-2USB	Stainless Steel pop up floor plate assembly, with 20 AMP (TR) duplex power/ 2USB (AC) receptacle

PUFPP-SQ-BR



PUFPP-SQ-BR-GFI



PUFPP-SQ-BR-USB



PUFPP-SQ-DB



PUFPP-SQ-DB-GFI



PUFPP-SQ-DB-USB



PUFPP-SQ-SS



PUFPP-SQ-SS-GFI



PUFPP-SQ-SS-USB



PUFPP-SQ-SS-20A-2USB



FEATURES & BENEFITS

- **UL recognized** 498, 514A, 943, 1059, and NEC 210.52(C). **CUL recognized** 22.2 #'s 42, 158, and 18.1-04.
- **Receptacles:** GFI – UL Listed E473428
2USB – UL Listed E491706
- All PUFPP styles supplied with **tamper resistant** receptacles

- **Pops out** when in use
- **Hides in the box** when not in use
- For **residential or commercial** applications
- Installs in **wood floors**
- **Scrub water tight** construction

>>>> All floor plates 4³/₄ W x 4³/₄ L x 3⁵/₈ H and include PUFPP-WB box



Conforms to UL STD.514A and 498;
Certified to CSA STD.C22.2.; No.18.1-04 and
42-M1984; LEW ELECTRIC FITTINGS CO.

PUFP Covers and Boxes

CATALOG #	DESCRIPTION
PUFP-B	6" Brass pop up floor plate with 15 AMP (TR) GFI receptacle
PUFP-BC	6" Brass pop up floor plate with 6 port Comm./Data device (max 3 CAT6 jacks)
PUFP-BD	6" Brass pop up floor plate with 15 AMP (TR) decora receptacle
PUFP-S	6" Stainless Steel pop up floor plate with 15 AMP (TR) GFI receptacle
PUFP-SC	6" Stainless Steel pop up floor plate with 6 port Comm./Data device (max 3 CAT6 jacks)
PUFP-SD	6" Stainless Steel pop up floor plate with 15 AMP (TR) decora receptacle
PUFP-LRA	Leveling ring for PUFP plates

CATALOG #	DESCRIPTION	DIMENSIONS	
		A	B
PUFP-HB	Concrete box for PUFP plates	4 5/16"	3 1/4"
PUFP-PB	Poly-Box for PUFP series covers	4 1/8"	3 1/8"
PUFP-WB	Wood floor box for PUFP plates	3 7/8"	3 1/8"
FB	PVC floor box (must use in conjunction with PUFP-LRA to mount cover); box UL listed #514C	5"	6"

PUFP-B



PUFP-BC



PUFP-BD



FEATURES & BENEFITS

- **UL recognized** 498, 514A, 943, 1059, and NEC 210.52(C).
CUL recognized 22.2 #'s 42, 158, and 18.1-04.
- **Pops out** when in use
- **Hides in the box** when not in use
- For **residential or commercial** applications
- Installs in **concrete or wood** floors
- **Scrub water tight** construction
- All PUFP style supplied with **tamper resistant** receptacles
- **Receptacles:** GFI – UL Listed E473428
 Decora – UL Listed E309821

PUFP-SD



PUFP-S



PUFP-SC



Conforms to UL STD.514A and 498;
 Certified to CSA STD.C22.2.; No.18.1-04 and
 42-M1984; LEW ELECTRIC FITTINGS CO.

PUFP-LRA



PUFP-HB

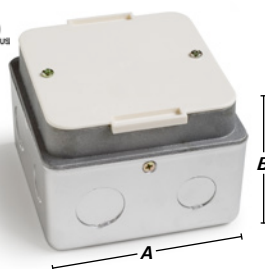

PUFP-PB



PUFP-WB

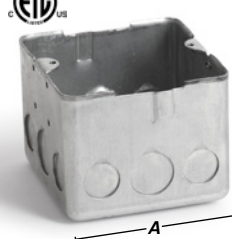

FB

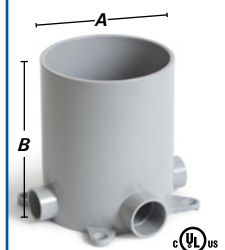





RCFB Boxes and Covers (Subfloor installation)

>>>> For Replacement Plugs, see page 49

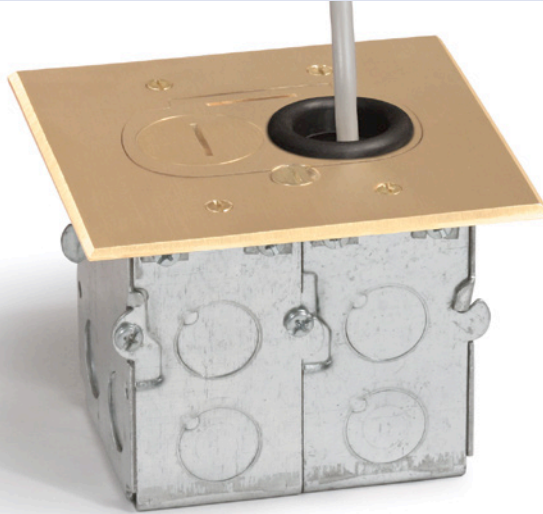
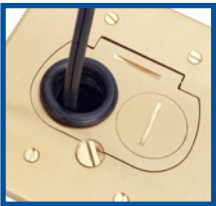
RCFB-1

RCFB-1: Recessed hybrid one gang floor box (Standard duplex receptacle only, cannot accommodate decora/GFI style receptacle)



Width	5"	Height	4"
Length	5"	Interior Capacity	36 Cu. In.
Finish Options			
 Brass » RCFB-1	 Aluminum » RCFB-1-A	 Dark Bronze » RCFB-1-DB	

REPLACEMENT COVER FOR RCFB-1





Replacement Cover

 Brass » RCFB-1-BP	 Aluminum » RCFB-1-AP
 Dark Bronze » RCFB-1-DBP	

RCFB-2

RCFB-2: Recessed hybrid two gang floor box (Standard duplex receptacle only, cannot accommodate decora/GFI style receptacle)





Width	5 1/16"	Height	4"
Length	8 5/8"	Interior Capacity	72 Cu. In.
Finish Options			
 Brass » RCFB-2	 Aluminum » RCFB-2-A	 Dark Bronze » RCFB-2-DB	

REPLACEMENT COVER FOR RCFB-2



Replacement Cover

 Brass » RCFB-2-BP	 Aluminum » RCFB-2-AP
 Dark Bronze » RCFB-2-DBP	

RCFB-1 & RCFB-2: UL & NEMA

- Box UL #E345966
- Tamper resistant receptacle UL #309821 (duplex)

RCFB-1 & RCFB-2: FEATURES & BENEFITS

- Water tight close up plugs
- Rubber grommets provided for wire protection

RB Series Wood Floor Box (Finished floor installation)

NEW

DESCRIPTION		
Round plastic floor box kit with spring loaded flip cover & 20 AMP (TR) single receptacle		
WIDTH (Cover Diameter)	HEIGHT	Interior Capacity
4.3"	2.65"	15.3 Cu. In.



FEATURES AND BENEFITS

- Lightweight polymer construction is designed for *easy installation* and provides *significant cost savings* over cast iron or metal floor boxes
- Spring loaded *flip cover automatically remains down* when not in use. There is no need for a screwdriver
- The plastic box comes with *self-tightening flanges, making installation in a finished floor quick and efficient*
- Available in *four cover finishes*
- *20 AMP Single Receptacle*



RB-OB

» Brass Metal Cover

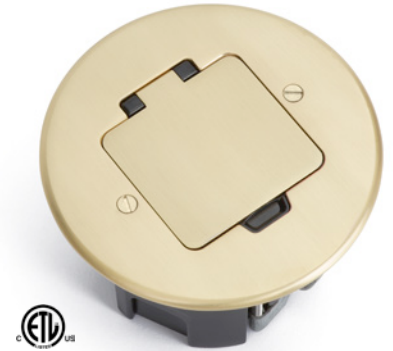

RB-OBK

» Black Metal Cover



RB-ODB

» Dark Bronze Metal Cover

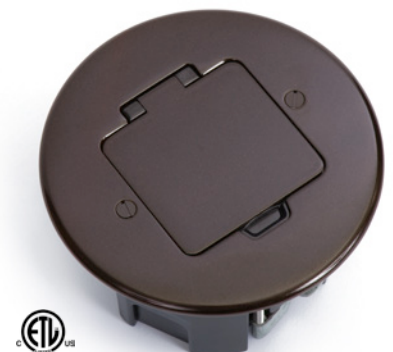

RB-ONS

» Nickel Silver Metal Cover

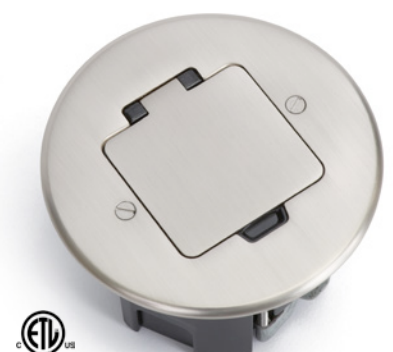

Plastic Boxes and Covers (Finished floor installation)

CATALOG #	DESCRIPTION	DIMENSIONS		INTERIOR CAPACITY
		A	B	
PBR-1	Round plastic box with 15 AMP (TR) duplex receptacle* included	4 3/8"	3 1/8"	20 Cu. In.
PBR1-FPA	Round plastic box kit with PBR-FPA Aluminum flip cover & 15 AMP (TR) receptacle*	5 1/16"	3 1/4"	20 Cu. In.
PBR-FPA	Aluminum flip cover for PBR-1	Diameter: 5 1/16"		
PBR1-FPB	Round plastic box kit with PBR-FPB Brass flip cover & 15 AMP (TR) receptacle*	5 1/16"	3 1/4"	20 Cu. In.
PBR-FPB	Brass flip cover for PBR-1	Diameter: 5 1/16"		
PBR1-FPDB	Round plastic box kit with PBR-FPDB Dark Bronze flip cover & 15 AMP (TR) receptacle*	5 1/16"	3 1/4"	20 Cu. In.
PBR-FPDB	Dark Bronze flip cover for PBR-1	Diameter: 5 1/16"		
PBR1-SPA	Round plastic box kit with PBR-SPA Aluminum screw cover & 15 AMP (TR) receptacle*	5 1/16"	3 1/4"	20 Cu. In.
PBR-SPA	Aluminum screw cover for PBR-1	Diameter: 5 1/16"		
PBR1-SPB	Round plastic box kit with PBR-SPB Brass screw cover & 15 AMP (TR) receptacle*	5 1/16"	3 1/4"	20 Cu. In.
PBR-SPB	Brass screw cover for PBR-1	Diameter: 5 1/16"		
PBR1-SPDB	Round plastic box kit with PBR-SPDB Dark Bronze screw cover & 15 AMP (TR) receptacle*	5 1/16"	3 1/4"	20 Cu. In.
PBR-SPDB	Dark Bronze screw cover for PBR-1	Diameter: 5 1/16"		

>>>> For Replacement Plugs, see page 49

* Standard duplex receptacle only, cannot accommodate decora/GFI style receptacle

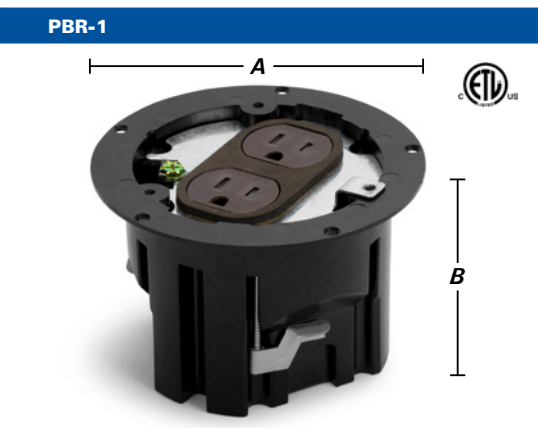

FEATURES & BENEFITS

- **Lightweight** polymer construction
- Options include **choice of metal covers** (aluminum, brass or dark bronze) and **closure style** (flip lid or screw plug)
- **Economical savings** over cast iron & stamped metal floor box assemblies
- **Ease of installation**
- **Adjustable wing clamps** for added installation support

Finished floor installation

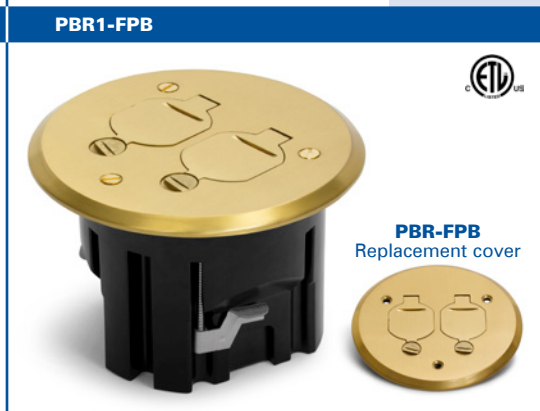
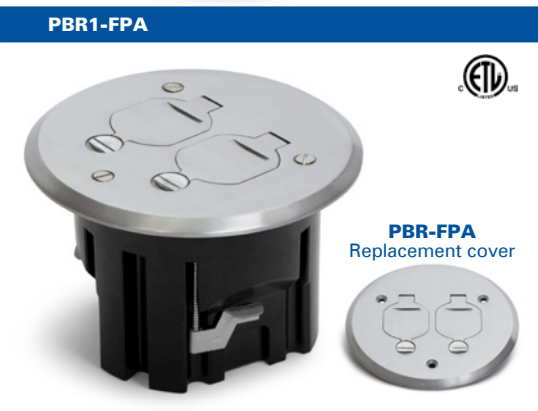
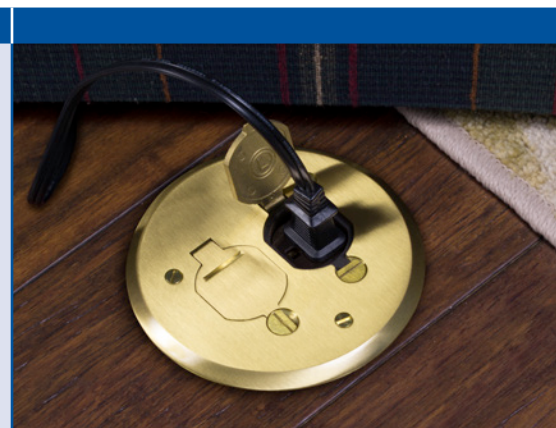

Plastic Boxes and Covers (Finished floor installation)

CATALOG #	DESCRIPTION	DIMENSIONS			INTERIOR CAPACITY
		L	W	H	
1101-PB	Single gang plastic box with 15 AMP (TR) duplex receptacle* included	4 3/4"	3 1/8"	3 3/8"	22.5 Cu. In.
PB1-FPA	Single gang plastic box kit with RRP-2-FPA Aluminum flip cover & 15 AMP (TR) receptacle*	5 1/8"	3 1/2"	3 5/8"	22.5 Cu. In.
RRP-2-FPA	Aluminum flip cover for 1101-PB	5 1/8"	3 1/2"		
PB1-FPB	Single gang plastic box kit with RRP-2-FPB Brass flip cover & 15 AMP (TR) receptacle*	5 1/8"	3 1/2"	3 5/8"	22.5 Cu. In.
RRP-2-FPB	Brass flip cover for 1101-PB	5 1/8"	3 1/2"		
PB1-SPA	Single gang plastic box kit with RRP-2-SPA Aluminum screw cover & 15 AMP (TR) receptacle*	5 1/8"	3 1/2"	3 5/8"	22.5 Cu. In.
RRP-2-SPA	Aluminum screw cover for 1101-PB	5 1/8"	3 1/2"		
PB1-SPB	Single gang plastic box kit with RRP-2-SPB Brass screw cover & 15 AMP (TR) receptacle*	5 1/8"	3 1/2"	3 5/8"	22.5 Cu. In.
RRP-2-SPB	Brass screw cover for 1101-PB	5 1/8"	3 1/2"		

»»» For Replacement Plugs, see page 49

* Standard duplex receptacle only, cannot accommodate decora/GFI style receptacle

1101-PB



FEATURES & BENEFITS

- **Lightweight** polymer construction
- Options include **choice of metal covers** (aluminum or brass) and **closure style** (flip lid or screw plug)
- **Economical savings** over cast iron & stamped metal floor box assemblies
- **Ease of installation**
- **Adjustable wing clamps** for added installation support



- **Conforms to UL514C**
- **ETL listing #4004534**

Finished floor installation



PB1-FPA



RRP-2-FPA
Replacement cover



PB1-FPB



RRP-2-FPB
Replacement cover



PB1-SPA



RRP-2-SPA
Replacement cover



PB1-SPB



RRP-2-SPB
Replacement cover



Plastic Boxes and Covers (Finished floor installation)

CATALOG #	DESCRIPTION	DIMENSIONS			INTERIOR CAPACITY
		L	W	H	
1102-PB	Two gang plastic box with (2) 15 AMP (TR) duplex receptacles* included	4 3/4"	4 3/4"	3 3/8"	45 Cu. In.
PB2-FPA ①	Two gang plastic box kit with RRP-4-FPA Aluminum flip cover & 2 15 AMP (TR) receptacles*	5"	5"	3 5/8"	45 Cu. In.
RRP-4-FPA	Aluminum flip cover for 1102-PB	5"	5"		
PB2-FPB ①	Two gang plastic box kit with RRP-4-FPB Brass flip cover & 2 15 AMP (TR) receptacles*	5"	5"	3 5/8"	45 Cu. In.
RRP-4-FPB	Brass flip cover for 1102-PB	5"	5"		
PB2-SPA ①	Two gang plastic box kit with RRP-4-SPA Aluminum screw cover & 2 15 AMP (TR) receptacles*	5"	5"	3 5/8"	45 Cu. In.
RRP-4-SPA	Aluminum screw cover for 1102-PB	5"	5"		
PB2-SPB ①	Two gang plastic box kit with RRP-4-SPB Brass flip cover & 2 15 AMP (TR) receptacles*	5"	5"	3 5/8"	45 Cu. In.
RRP-4-SPB	Brass screw cover for 1102-PB	5"	5"		

① Also includes one RRP-2-PQ quad port

* Standard duplex receptacle only, cannot accommodate decora/GFI style receptacle

>>>> For Replacement Plugs, see page 49

1102-PB



FEATURES & BENEFITS

- **Lightweight** polymer construction
- Options include **choice of metal covers** (aluminum or brass) and **closure style** (flip lid or screw plug)
- **Economical savings** over cast iron & stamped metal floor box assemblies
- **Ease of installation**
- **Adjustable wing clamps** for added installation support
- **Partitions are removable**



Intertek
4004534

- **Conforms to UL514C**
- **ETL listing #4004534**

Finished floor installation

PB2-FPA (Includes RRP-2-PQ Quad Port, max 2 CAT6 jacks)



PB2-FPB (Includes RRP-2-PQ Quad Port, max 2 CAT6 jacks)

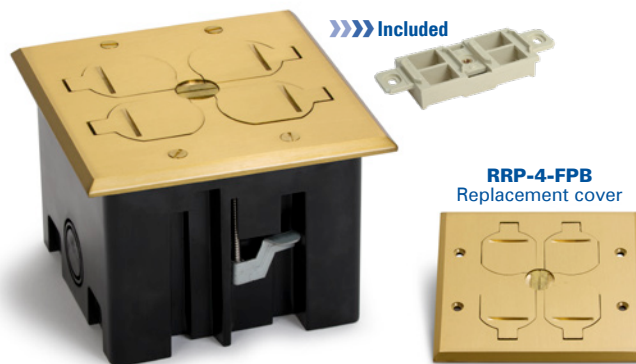

PB2-SPA (Includes RRP-2-PQ Quad Port, max 2 CAT6 jacks)



PB2-SPB (Includes RRP-2-PQ Quad Port, max 2 CAT6 jacks)



Plastic Boxes and Covers (Finished floor installation)

CATALOG #	DESCRIPTION	DIMENSIONS			INTERIOR CAPACITY
		L	W	H	
1103-PB	Three gang plastic box with (3) 15 AMP (TR) duplex receptacles* included	4 3/4"	6 5/8"	3 3/8"	64 Cu. In.
PB3-FPA ①	Three gang plastic box kit with RRP-6-FPA Aluminum flip cover & 3 15 AMP (TR) receptacles*	5 1/8"	6 15/16"	3 5/8"	64 Cu. In.
RRP-6-FPA	Aluminum flip cover for 1103-PB	5 1/8"	6 15/16"		
PB3-FPB ①	Three gang plastic box kit with RRP-6-FPB Brass flip cover & 3 15 AMP (TR) receptacles*	5 1/8"	6 15/16"	3 5/8"	64 Cu. In.
RRP-6-FPB	Brass flip cover for 1103-PB	5 1/8"	6 15/16"		
PB3-SPA ①	Three gang plastic box kit with RRP-6-SPA Aluminum screw cover & 3 15 AMP (TR) receptacles*	5 1/8"	6 15/16"	3 5/8"	64 Cu. In.
RRP-6-SPA	Aluminum screw cover for 1103-PB	5 1/8"	6 15/16"		
PB3-SPB ①	Three gang plastic box kit with RRP-6-SPB Brass flip cover & 3 15 AMP (TR) receptacles*	5 1/8"	6 15/16"	3 5/8"	64 Cu. In.
RRP-6-SPB	Brass screw cover for 1103-PB	5 1/8"	6 15/16"		

① Also includes one RRP-2-PQ quad port

*Standard duplex receptacle only, cannot accommodate decora/GFI style receptacle

»»»» For Replacement Plugs, see page 49

1103-PB



FEATURES & BENEFITS

- **Lightweight** polymer construction
- Options include **choice of metal covers** (aluminum or brass) and **closure style** (flip lid or screw plug)
- **Economical savings** over cast iron & stamped metal floor box assemblies
- **Ease of installation**
- **Adjustable wing clamps** for added installation support
- **Partitions are removable**



Intertek
4004534

- **Conforms to UL514C**
- **ETL listing #4004534**

Finished floor installation

PB3-FPA (Includes RRP-2-PQ Quad Port, max 2 CAT6 jacks)

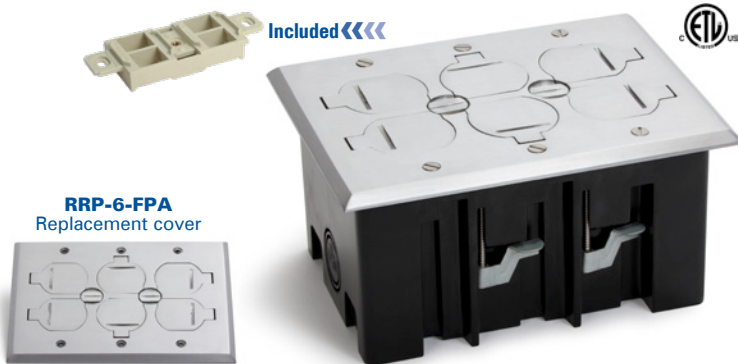

PB3-FPB (Includes RRP-2-PQ Quad Port, max 2 CAT6 jacks)

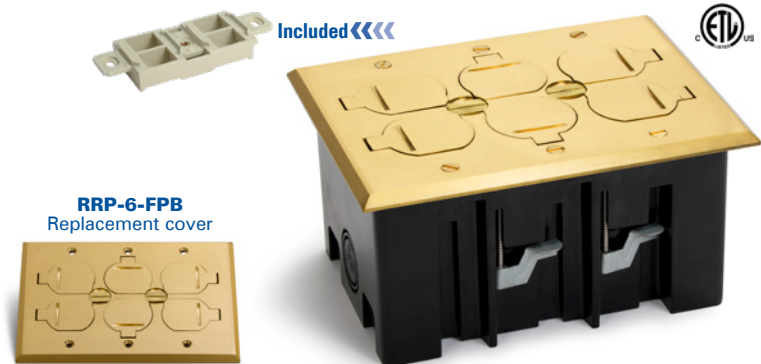

PB3-SPA (Includes RRP-2-PQ Quad Port, max 2 CAT6 jacks)



PB3-SPB (Includes RRP-2-PQ Quad Port, max 2 CAT6 jacks)



Resi Poke-Through NEW

FEATURES & BENEFITS

- **Totally enclosed and partitioned compartments** for Power / Voice / Data in one unit
- **4 to 10 jack openings** for Voice and Data in one unit
- **Threaded conduit openings** reduce the risk of tampering
- **Completely flush** with 1/4" carpet or other flooring
- Recessed configuration allows for **cover to be closed while in use**



Conforms to UL 514A
LEW ELECTRIC
FITTINGS CO.



5"

MOI4-RES-REC

3.985"



COVER

Articulated Hinged Cover – Cable Exit Door (AHC-CED)

- » Outer ring diameter = 5.9"
- » Inner ring diameter = 3.985"
- » Color options: ■ Stainless Steel
■ Brass
■ Black



How to Order

STEP 1 » MOI4-RES-REC



MOI4-RES-REC

STEP 2 » Choose Configuration * (20amp standard, 15amp available)

*Configuration does not include communication components

	COMM10 » Ten communication openings • Bottom Plate #4		PWR2-COMM5 » (2) single receptacle & (5) communication openings • Bottom Plate #4
	DP1 » Decora receptacle • Bottom Plate #2		PWR2-COMM6 » (2) single receptacle & (6) communication openings • Bottom Plate #4
	DP1-COMM4 » Decora receptacle & (4) communication openings • Bottom Plate #1		PWR4 » (4) single receptacle • Bottom Plate #2
	PASS-THROUGH » 2.5" trade size circular opening • Bottom Plate #5		PWR4-COMM4 » (4) single receptacle & (4) communication openings • Bottom Plate #4
	PWR2-COMM4 » (2) single receptacle & (4) communication openings • Bottom Plate #4		SYS-COMM » Systems furniture communication-power & comm cabling • Bottom Plate #4
	PWR2-COMM4-DB15 » (2) single receptacle & (4) communication openings & (1) DB-15 opening • Bottom Plate #4		AV-COMM4 » (1) Decora opening for CI-5BWPA (4) communication openings • Bottom Plate #3

EXAMPLE: MOI4-RES-REC-PWR4-COMM4

Bottom Plate #1	Bottom Plate #2	Bottom Plate #3	Bottom Plate #4	Bottom Plate #5
NPS 0.50" x3	NPS 0.50"	NPS 0.75" NPS 0.50" x2	NPS 0.75" NPS 1.25"	NPS 1" NPS 1.25"

STEP 3 » Choose Cover Finish (AHC-CED Cover only for MOI4-RES-REC)

Stainless Steel Add: -SS	Brass Add: -BR	Black Add: -BK

EXAMPLE: » MOI4-RES-REC-PWR4-COMM4-BK-AHC-CED

EXAMPLE

MOI4-RES-REC-PWR4-COMM4-BK-AHC-CED



Residential Floor Boxes

LEW ELECTRIC FITTINGS COMPANY
For more information, call 877-537-2019
www.lewelectric.com

28 >>>>> PUPF Series | RCFB Series | RB Series | Plastic Box Series | Resi Poke-Through | RRP Series | SWB Series | 812 Series



RRP Boxes and Covers (Subfloor installation)

»»»» For Replacement Plugs, see page 49

RRP-1-BP

RRP-1-BP: Plated recessed floor plate assembly (single receptacle); includes 15 AMP (TR) receptacle

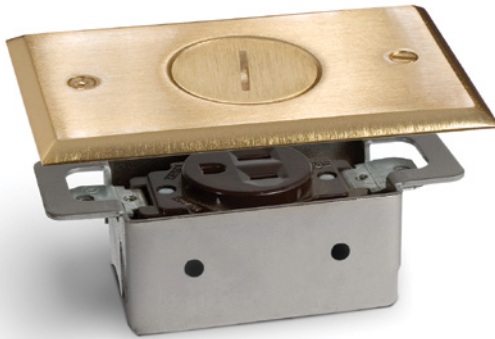

Width
2 13/16"

Length
4 5/8"

Finish Options

Brass Plated » RRP-1-BP

Dark Bronze Plated » RRP-1-DB

Nickel Plated » RRP-1-NP

Replacement Cover

Brass Plated » RRP-1-BPR	Dark Bronze Plated » RRP-1-DBR	Nickel Plated » RRP-1-NPR
--------------------------	--------------------------------	---------------------------

RRP-2

RRP-2: Recessed floor plate assembly (duplex receptacle); includes 15 AMP (TR) receptacle (Standard duplex receptacle only, cannot accommodate decora/GFI style receptacle)

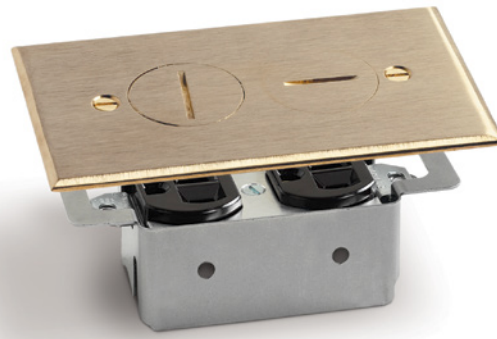

Width
2 7/8"

Length
5"

Finish Options

Brass » RRP-2

Aluminum » RRP-2-A

Dark Bronze » RRP-2-DB

Nickel Silver » RRP-2-NS

Replacement Cover

Brass » RRP-2-BR	Aluminum » RRP-2-AR	Dark Bronze » RRP-2-DBR	Nickel Silver » RRP-2-NSR
------------------	---------------------	-------------------------	---------------------------

RRP-2-T

RRP-2-T: Recessed floor plate assembly (duplex Comm./Data); RRP-2-PQ quad port included

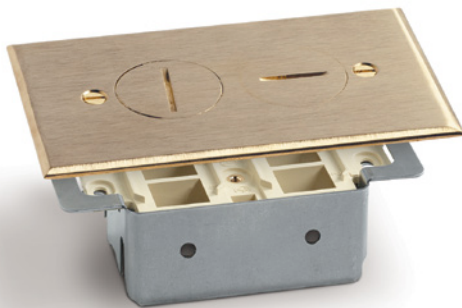

Width
2 7/8"

Length
5"

Finish Options

Brass » RRP-2-T

Aluminum » RRP-2-A-T

Dark Bronze » RRP-2-DB-T

Nickel Silver » RRP-2-NS-T

Replacement Cover

Brass » RRP-2-BR	Aluminum » RRP-2-AR	Dark Bronze » RRP-2-DBR	Nickel Silver » RRP-2-NSR
------------------	---------------------	-------------------------	---------------------------

RRP-2-LR

RRP-2-LR: Recessed floor plate flip lid assembly (duplex receptacle); includes 15 AMP (TR) receptacle (Standard duplex receptacle only, cannot accommodate decora/GFI style receptacle)

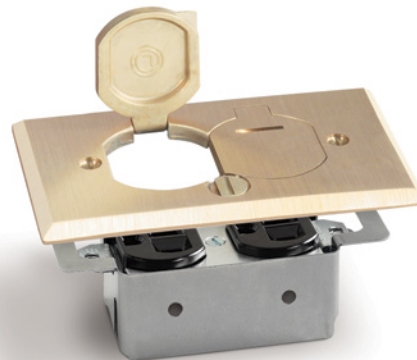

Width
2 7/8"

Length
5"

Finish Options

Brass » RRP-2-LR

Aluminum » RRP-2-LR-A

Dark Bronze » RRP-2-LR-DB

Replacement Cover

Brass » RRP-2-LRR	Aluminum » RRP-2-LR-AR	Dark Bronze » RRP-2-LR-DBR
-------------------	------------------------	----------------------------

RRP-2-LR-T

RRP-2-LR-T: Recessed floor plate flip lid assembly (duplex Comm./Data); RRP-2-PQ quad port included

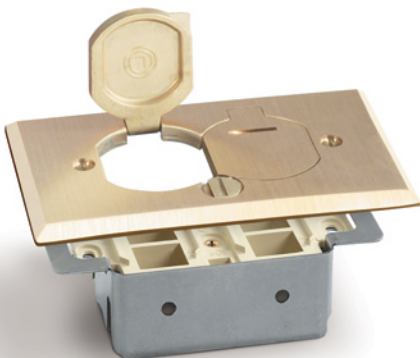

Width
2 7/8"

Length
5"

Finish Options

Brass » RRP-2-LR-T

Aluminum » RRP-2-LR-A-T

Dark Bronze » RRP-2-LR-DB-T

Replacement Cover

Brass » RRP-2-LRR	Aluminum » RRP-2-LR-AR	Dark Bronze » RRP-2-LR-DBR
-------------------	------------------------	----------------------------

RRP: UL & NEMA RECOGNITION

- Meets NEMA WD1-1983 heavy duty requirement for display receptacle
- All receptacles tamper resistant; UL listing #E309821 (duplex); E237396 (single)

RRP: FEATURES & BENEFITS

- Fits any manufacturer's 3 1/2" deep switch box
- Receptacle with neoprene gasket included
- Water tight assembly
- Adjustable up to 3/4" to accommodate any floor

Subfloor installation

SWB Boxes and Covers (Subfloor installation)

>>>> For Replacement Plugs, see page 49

SWB-1-BP

SWB-1-BP: Plated recessed floor plate assembly (single receptacle with box); includes 15 AMP (TR) receptacle.

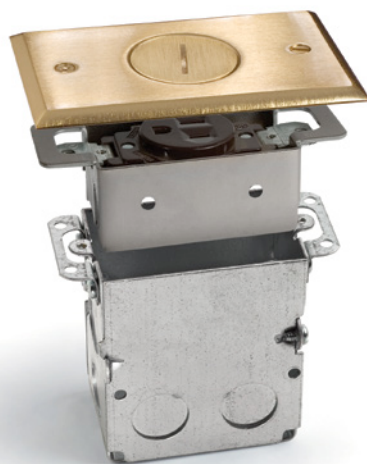

Width	2 13/16"	Finish Options
Length	4 5/8"	Brass Plated » SWB-1-BP
Height	4"	Dark Bronze Plated » SWB-1-DB
Interior Capacity	18 Cu. In.	Nickel Plated » SWB-1-NP

Replacement Cover
Brass Plated » RRP-1-BPR
Dark Bronze Plated » RRP-1-DBR
Nickel Plated » RRP-1-NPR

SWB-2

SWB-2: Recessed floor plate assembly (duplex receptacle with box); includes 15 AMP (TR) receptacle (Standard duplex receptacle only, cannot accommodate decora/GFI style receptacle)

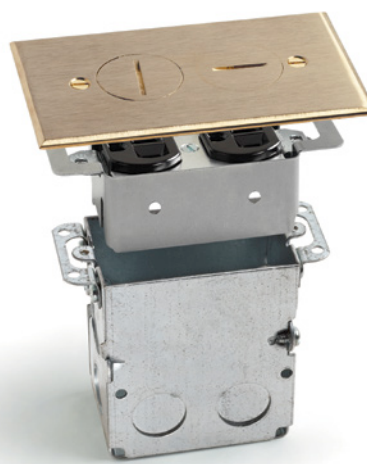

Width	2 7/8"	Finish Options
Length	5"	Brass » SWB-2
Height	4"	Aluminum » SWB-2-A
Interior Capacity	18 Cu. In.	Dark Bronze » SWB-2-DB
		Nickel Silver » SWB-2-NS

Replacement Cover
Brass » RRP-2-BR
Aluminum » RRP-2-AR
Dark Bronze » RRP-2-DBR
Nickel Silver » RRP-2-NSR

SWB-2-T

SWB-2-T: Recessed floor plate assembly (Comm./Data with box); RRP-2-PQ quad port included

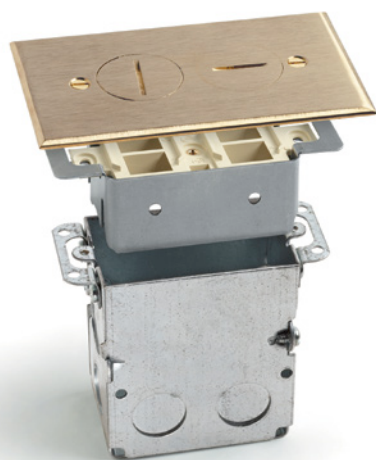

Width	2 7/8"	Finish Options
Length	5"	Brass » SWB-2-T
Height	4"	Aluminum » SWB-2-A-T
Interior Capacity	18 Cu. In.	Dark Bronze » SWB-2-DB-T
		Nickel Silver » SWB-2-NS-T

Replacement Cover
Brass » RRP-2-BR
Aluminum » RRP-2-AR
Dark Bronze » RRP-2-DBR
Nickel Silver » RRP-2-NSR

SWB-2-LR

SWB-2-LR: Recessed floor plate flip lid assembly (duplex receptacle with box); includes 15 AMP (TR) receptacle (Standard duplex receptacle only, cannot accommodate decora/GFI style receptacle)



Width	2 7/8"	Finish Options
Length	5"	Brass » SWB-2-LR
Height	4"	Aluminum » SWB-2-LR-A
Interior Capacity	18 Cu. In.	Dark Bronze » SWB-2-LR-DB

Replacement Cover
Brass » RRP-2-LRR
Aluminum » RRP-2-LR-AR
Dark Bronze » RRP-2-LR-DBR

SWB-2-LR-T

SWB-2-LR-T: Recessed floor plate flip lid assembly (Comm./Data with box); RRP-2-PQ quad port included



Width	2 7/8"	Finish Options
Length	5"	Brass » SWB-2-LR-T
Height	4"	Aluminum » SWB-2-LR-A-T
Interior Capacity	18 Cu. In.	Dark Bronze » SWB-2-LR-DB-T

Replacement Cover
Brass » RRP-2-LRR
Aluminum » RRP-2-LR-AR
Dark Bronze » RRP-2-LR-DBR

SWB: UL & NEMA RECOGNITION

- Box UL #E345966
- Meets NEMA WD1-1983 heavy duty requirement for display receptacle
- All receptacles tamper resistant; UL listing #E309821 (duplex); E237396 (single)

SWB: FEATURES & BENEFITS

- Water tight assembly
- 1/2" Conduit knockouts
- Adjustable up to 3/4" to accommodate any floor

Subfloor installation

SWB Boxes and Covers (Subfloor installation)

>>>> For Replacement Plugs, see page 49

SWB-4: Two gang, divided, recessed floor plate assembly with screw plug cover. Includes 2 15 AMP (TR) receptacles. *One RRP-2-PQ quad port also included.* (Standard duplex receptacle only, cannot accommodate decora/GFI style receptacle)

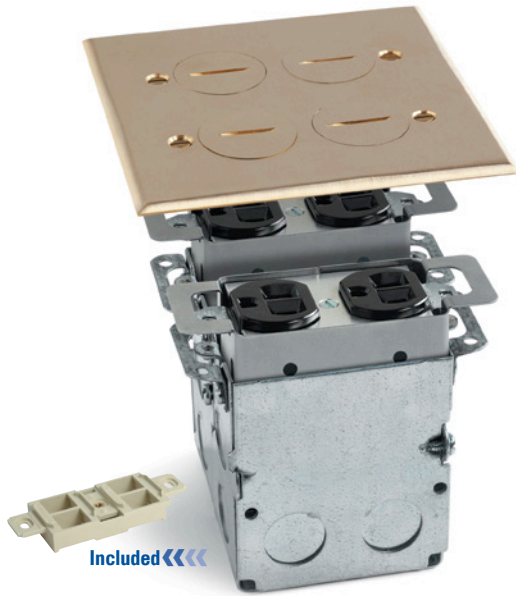

Width	5"
Length	5"
Height	4"
Finish Options	
	Brass » SWB-4
	Aluminum » SWB-4-A
	Dark Bronze » SWB-4-DB
Replacement Cover	
	Brass » RRP-4-BP
	Aluminum » RRP-4-AP
	Dark Bronze » RRP-4-DBP

SWB-4-LR: Two gang, divided, recessed floor plate assembly with flip lid cover. Includes 2 15 AMP (TR) receptacles. *One RRP-2-PQ quad port also included.* (Standard duplex receptacle only, cannot accommodate decora/GFI style receptacle)



Width	5"
Length	5"
Height	4"
Finish Options	
	Brass » SWB-4-LR
	Aluminum » SWB-4-LR-A
	Aluminum » SWB-4-LR-DB
Replacement Cover	
	Brass » RRP-4-BP-LR
	Aluminum » RRP-4-AP-LR
	Dark Bronze » RRP-4-DBP-LR

SWB-6: Three gang, divided, recessed floor plate assembly with screw plug cover. Includes 3 15 AMP (TR) receptacles. *One RRP-2-PQ quad port also included.* (Standard duplex receptacle only, cannot accommodate decora/GFI style receptacle)



Width	5"
Length	6 7/8"
Height	4"
Finish Options	
	Brass » SWB-6
	Aluminum » SWB-6-A
Replacement Cover	
	Brass » RRP-6-BP
	Aluminum » RRP-6-AP

SWB-6-LR: Three gang, divided, recessed floor plate assembly with flip lid cover. Includes 3 15 AMP (TR) receptacles. *One RRP-2-PQ quad port also included.* (Standard duplex receptacle only, cannot accommodate decora/GFI style receptacle)



Width	5"
Length	6 7/8"
Height	4"
Finish Options	
	Brass » SWB-6-LR
	Aluminum » SWB-6-LR-A
Replacement Cover	
	Brass » RRP-6-BP-LR
	Aluminum » RRP-6-AP-LR

SWB-4 & SWB-6: UL & NEMA RECOGNITION

- Box UL #E345966
- Meets NEMA WD1-1983 heavy duty requirement for display receptacle
- All receptacles tamper resistant; UL listing #E309821 (duplex); E237396 (single)

SWB-4 & SWB-6: FEATURES & BENEFITS

- **Water tight** assembly
 - 1/2" Conduit **knockouts**
 - **Adjustable** up to 3/4" to accommodate any floor
 - **Partitions are removable**
- Subfloor installation**

812 Boxes (Concrete or wood floor)

>>>> 812 Series UL listing #514A,
#498 and CUL recognized 22.2 #18.1-04
>>>> UL listed receptacle #E309821
>>>> For Replacement Plugs, see page 49

812

812: Cast iron round floor box with duplex receptacle (Does not include cover)
(Standard duplex receptacle only, cannot accommodate decora/GFI style receptacle)

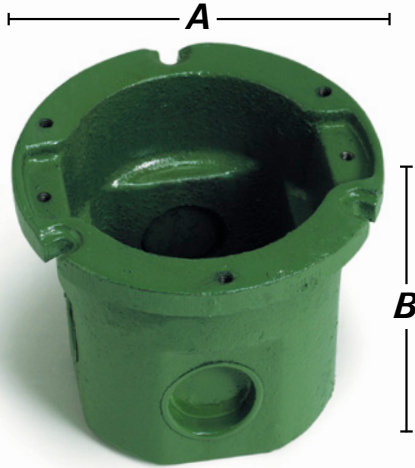





Width (A)	4"
Height (B)	3"
Conduit Openings	Sides (2)- $\frac{3}{4}$ " & (2)- $\frac{1}{2}$ " Bottom (2)- $\frac{1}{2}$ "
Interior Capacity	14.5 Cu. In.

812-DFB

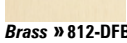
812-DFB: Floor box furnished with 523-DP Cover & 15 AMP (TR) duplex receptacle
(Standard duplex receptacle only, cannot accommodate decora/GFI style receptacle)





Width (A)	4"
Height (B)	3 $\frac{1}{8}$ "
Conduit Openings	Sides (2)- $\frac{3}{4}$ " & (2)- $\frac{1}{2}$ " Bottom (2)- $\frac{1}{2}$ "
Interior Capacity	14.5 Cu. In.
Finish Options	 Brass » 812-DFB  Aluminum » 812-DFB-A  Dark Bronze » 812-DFB-DB  Nickel Silver » 812-DFB-NS

812-DFB-LR

812-DFB-LR: Floor box furnished with DFB-LR Cover & 15 AMP (TR) duplex receptacle
(Standard duplex receptacle only, cannot accommodate decora/GFI style receptacle)

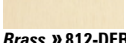



Width (A)	4"
Height (B)	3 $\frac{5}{8}$ "
Conduit Openings	Sides (2)- $\frac{3}{4}$ " & (2)- $\frac{1}{2}$ " Bottom (2)- $\frac{1}{2}$ "
Interior Capacity	14.5 Cu. In.
Finish Options	 Brass » 812-DFB-LR  Aluminum » 812-DFB-LR-A  Dark Bronze » 812-DFB-LR-DB

812-DFB-W/DFB-1

812-DFB-W/DFB-1: Floor box furnished with DFB-1 Cover & 15 AMP (TR) duplex receptacle
(Standard duplex receptacle only, cannot accommodate decora/GFI style receptacle)

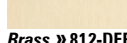

Width (A)	4"
Height (B)	3 $\frac{5}{8}$ "
Conduit Openings	Sides (2)- $\frac{3}{4}$ " & (2)- $\frac{1}{2}$ " Bottom (2)- $\frac{1}{2}$ "
Interior Capacity	14.5 Cu. In.
Finish Options	 Brass » 812-DFB-W/DFB-1  Aluminum » 812-DFB-W/DFB-1-A  Dark Bronze » 812-DFB-W/DFB-1-DB



812 Covers and Flanges

1 Standard duplex receptacle only, cannot accommodate decora/GFI style receptacle
 >>>> For Replacement Plugs, see page 49

523-DP

523-DP: 4" cover (1/8" thick) with (2) 1 1/2" screw plugs for duplex 1



Finish Options

 Brass » 523-DP	 Aluminum » 523-DP-A
 Dark Bronze » 523-DP-DB	 Nickel Silver » 523-DP-NS

524

524: 4" cover (1/8" thick) with 2" - 1/2" combo plug for Comm./Data



Finish Options

 Brass » 524

DFB-LR

DFB-LR: 4" dual hinged cover (1/4" thick) for duplex 1

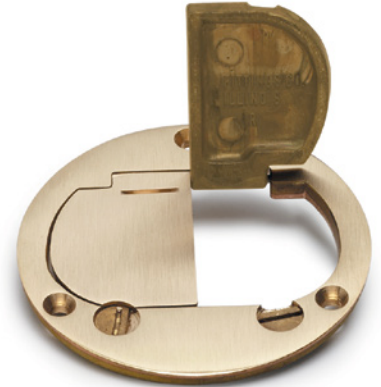

Finish Options

 Brass » DFB-LR	 Aluminum » DFB-LR-A	 Dark Bronze » DFB-LR-DB
--	---	---

DFB-1

DFB-1: 4" hinged cover (1/4" thick) for duplex 1



Finish Options





 Brass » DFB-1	 Aluminum » DFB-1-A	 Dark Bronze » DFB-1-DB
--	--	--

SCF-1

SCF-1: 5 1/4" flange



Finish Options





 Brass » SCF-1	 Aluminum » SCF-1-A	 Dark Bronze » SCF-1-DB
 Clear Plastic » SCF-1-CP	 Nickel Silver » SCF-1-NS	

TCP-1

TCP-1: 5 3/4" flanged cover, with 2" - 1/2" combo plug for Comm./Data. or single receptacle

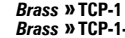

Finish Options





 Brass » TCP-1	 Nickel Silver » TCP-1-NS
 Brass » TCP-1-3/4"	
 Brass » TCP-1-1"	

TCP-2

TCP-2: 5 3/4" flanged cover, with (2) 1 1/2" screw plugs for duplex power or Comm./Data 1



Finish Options



 Brass » TCP-2	 Aluminum » TCP-2-A
 Dark Bronze » TCP-2-DB	 Nickel Silver » TCP-2-NS

TCP-2-LR

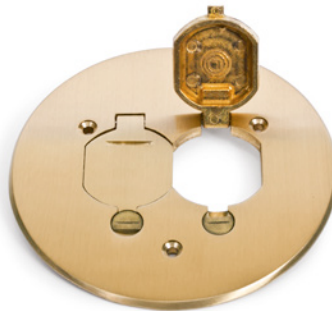
TCP-2-LR: 5 3/4" Seamless flanged cover, with dual flip lid and duplex mounting plate 1



Finish Options

 Brass » TCP-2-LR	 Aluminum » TCP-2-LR-A
 Dark Bronze » TCP-2-LR-DB	

All covers page 33: ETL listed 4004534,
 UL listed 514D, CSA 22.2#42, Marked  UL listed 498

OUTDOOR Floor Box

CATALOG #	DESCRIPTION
OB-1-SP	Outdoor floor box with Stainless Steel cover; Push Button Open ; Includes 20 AMP WR/TR GFI receptacle; Fully IP66 rated water proof (<i>when in closed position</i>). Includes wrench for inside wire connections.
OB-1-SH	Outdoor floor box with Stainless Steel cover; Hex Key Open ; Includes 20 AMP WR/TR GFI receptacle; Fully IP66 rated water proof (<i>when in closed position</i>). Includes wrench for inside wire connections.
OB-1-SP-6PORT ①	Outdoor floor box for Comm./Data with Stainless Steel cover: Push Button Open ; Fully IP66 rated water proof (<i>when in closed position</i>). Includes wrench for inside wire connections.
OB-1-SH-6PORT ①	Outdoor floor box for Comm./Data with Stainless Steel cover: Hex Key Open ; Fully IP66 rated water proof (<i>when in closed position</i>). Includes wrench for inside wire connections.

>>>> ① Max 3 CAT6 jacks per six port

OB-1-SP

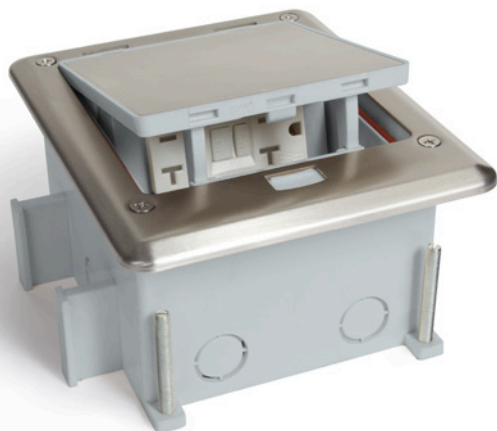

OB-1-SH

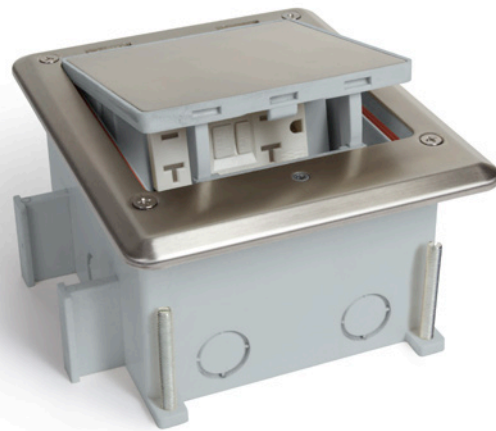
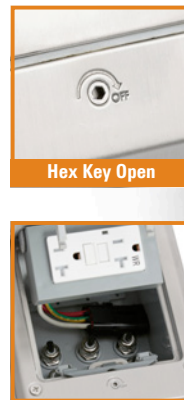

OB-1-SP-6PORT

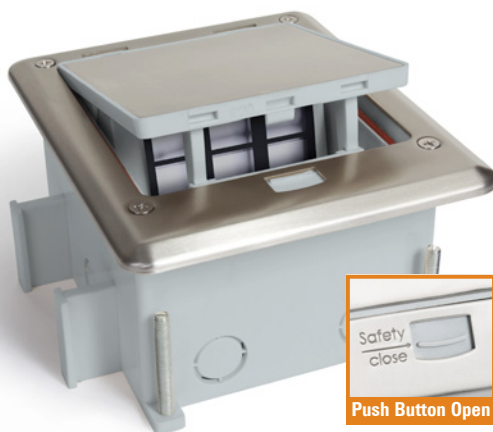

OB-1-SH-6PORT

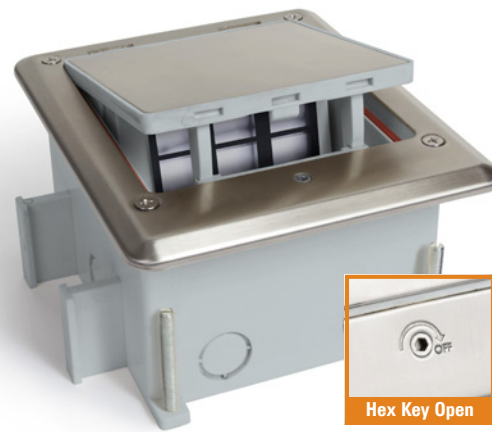

BOX SPECIFICATIONS

- Cover is 6 7/8" L x 5 11/16" W
- Overall height with box and extension ring is 6 1/2"
- Minimum depth can be adjusted upwards of 1 3/4"
- Box dimensions are 5 1/4" L x 4 3/4" W (the cover hangs over more on one side of the box than the other)
- Cover screws are M-4 metric size (3.5 inch, 2 inch and 1 inch screws all provided)



FEATURES & BENEFITS

- **Intertek IP66 RATED** BOX (when in closed position)
- **Receptacle:** GFI – UL Listed E473428
- **Tamper Proof opening** (with hex key option)
- **Gangable**
- Includes **weather resistant** UL listed receptacle
- **Patent protected**
- **Stainless Steel #316:** increases general corrosion resistance, improves resistance to pitting from chloride ion solutions, and provides increased strength at elevated temperatures.

OUTDOOR Countertop Box

CATALOG #	DESCRIPTION
OB-2-CT-SP	Countertop box for covered outdoor kitchens, with Stainless Steel cover; Push Button Open ; Includes 20 AMP WR/TR GFI receptacle; Fully IP66 rated water proof (<i>when in closed position</i>). Includes nine foot 20 amp power cord.



CONFORMS TO UL STD.962A AND 943
 CERTIFIED TO CSA STD.C22.2#308 AND 144.1

OB-2-CT-SP

FEATURES & BENEFITS

- **Intertek IP66 RATED** BOX (when in closed position)
- **Receptacle:** GFI – UL Listed E473428
- Includes **weather resistant/tamper proof** UL listed receptacle
- **Stainless Steel #316:** increases general corrosion resistance, improves resistance to pitting from chloride ion solutions, and provides increased strength at elevated temperatures.
- Includes **nine foot 20 amp power cord**

BOX SPECIFICATIONS

- **Cover Dimensions:** 6.8125" L x 5.625" W
- **Total Height with Cover:** 3.1"

DEK-BOX® NEW

CATALOG #	DESCRIPTION
DB-1-DB-GFI	Outdoor deck box with brown plastic cover, heavy duty/weather proof & (TR) GFCI receptacle, 2-foot cord and weather proof junction box
DB-1-DB-DX	Outdoor deck box with brown plastic cover, heavy duty/weather proof & (TR) duplex receptacle, 2-foot cord and weather proof junction box
DB-1-DB	Outdoor deck box with brown plastic cover, 2-foot cord and weather proof junction box (NO RECEPTACLE SUPPLIED)

DB1-DB-GFI

FEATURES & BENEFITS

- 20-amp, heavy duty, **weather proof, tamper resistant receptacle**
- **Marine grade water tight junction box**
- **Tamper resistant opening**
- Includes weather resistant **UL listed receptacle** E362676 or E473428
- Includes **2-foot 20-amp whip**
- **ETL listed** 4004534; **UL listed** 514D; **CSA 22.2#42**
- **Cutout template provided**

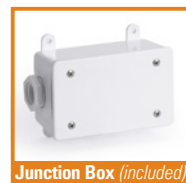
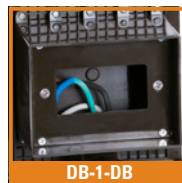

DB-1-DB-GFI

DB-1-DB-DX

DB-1-DB

Junction Box (included)

BOX SPECIFICATIONS

- **Cover Dimensions:** 9 13/16" x 6 7/8"

PVC Box & Accessories

CATALOG #	DESCRIPTION	DIMENSIONS		INTERIOR CAPACITY
		A	B	
FB	Round PVC box with (2) 3/4" hubs, (2) 1" hubs, (2) 3/4" reducers, (4) 1/2" reducers, ADAPTER RING NOT INCLUDED.	5"	6"	90 Cu. In. (15.5/In.)
FBKIT	Round PVC box with (2) 3/4" hubs, (2) 1" hubs, (2) 3/4" reducers, (4) 1/2" reducers, ADAPTER RING INCLUDED.	5"	6"	90 Cu. In. (15.5/In.)
CATALOG #	DESCRIPTION			
FB-DIV	Divider for FB & FBKIT floor boxes			
LRA-U	Leveling ring for FB & FBKIT			
PUFP-LRA	Leveling ring for PUFP plates			

>>>> UL listing #514C

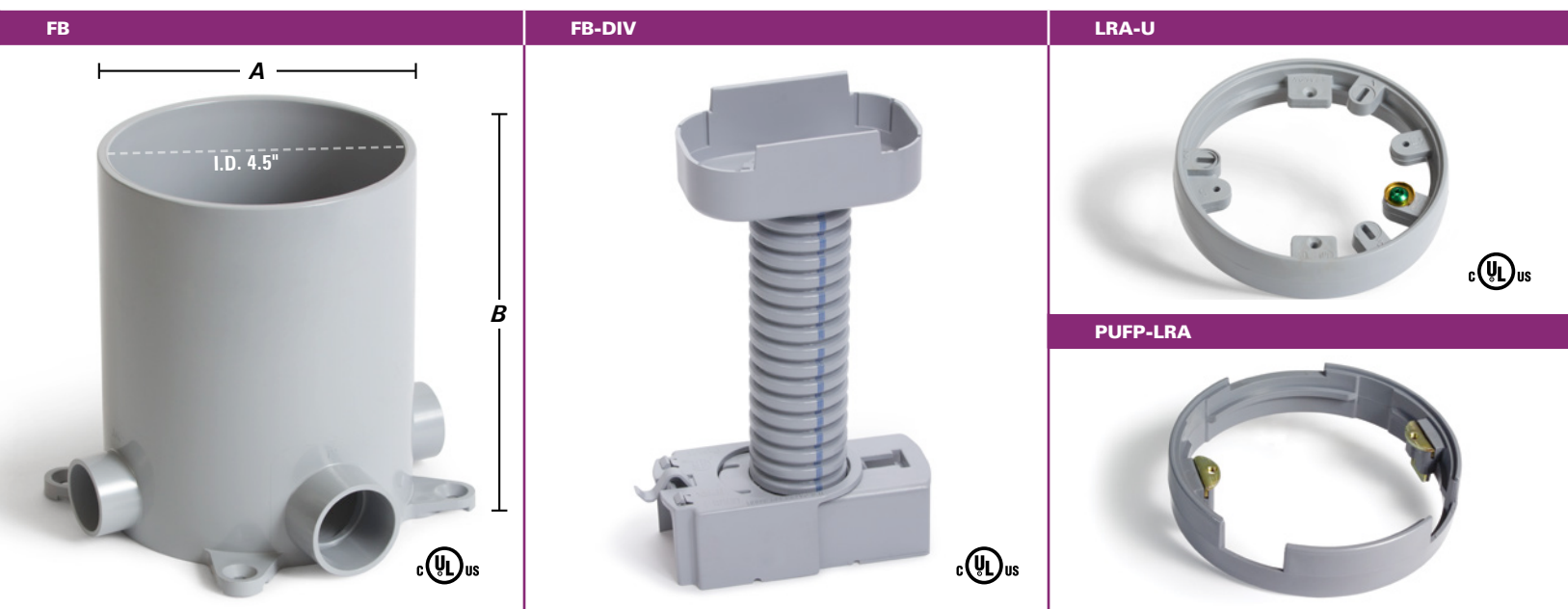

Non-Metallic Covers

CATALOG #	DESCRIPTION
PFC-B	5 3/4" Brown plastic flanged cover with single flip lid. Includes mounting plates and gaskets for duplex receptacle, GFI/decora receptacle and single receptacle/Data.
PFC-E	5 3/4" Ebony plastic flanged cover with single flip lid. Includes mounting plates and gaskets for duplex receptacle, GFI/decora receptacle and single receptacle/Data.
PFC-G	5 3/4" Gold plastic flanged cover with single flip lid. Includes mounting plates and gaskets for duplex receptacle, GFI/decora receptacle and single receptacle/Data.
PFC-S	5 3/4" Gray plastic flanged cover with single flip lid. Includes mounting plates and gaskets for duplex receptacle, GFI/decora receptacle and single receptacle/Data.
PFC-T	5 3/4" Tan plastic flanged cover with single flip lid. Includes mounting plates and gaskets for duplex receptacle, GFI/decora receptacle and single receptacle/Data.

>>>> All covers listed above: UL listing #514C

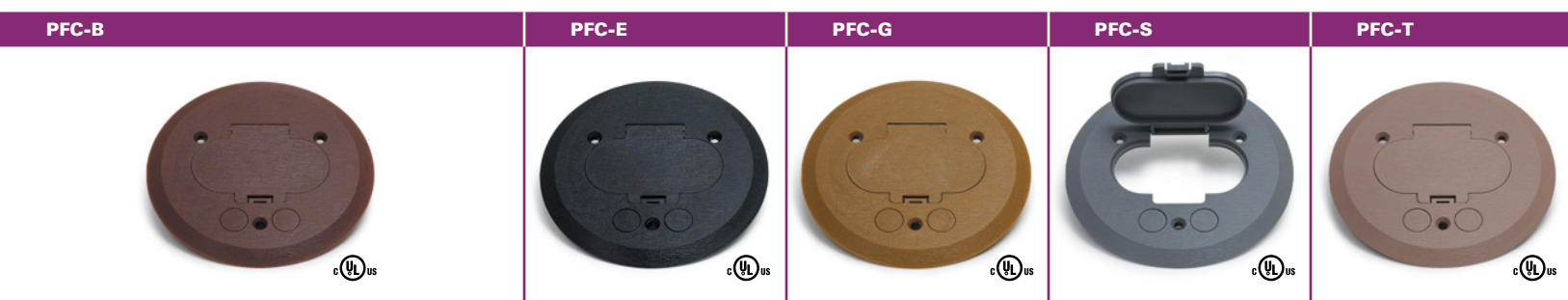

PVC Metal Covers

For Replacement Plugs, see page 49

CATALOG #	DESCRIPTION
PUFP-B ①	6" Brass pop up floor plate with with 15 AMP (TR) GFI receptacle
PUFP-BC ①	6" Brass pop up floor plate with 6 port Comm./Data device (max 3 CAT6 jacks)
PUFP-BD ①	6" Brass pop up floor plate with 15 AMP (TR) decora receptacle
PUFP-S ①	6" Stainless Steel pop up floor plate with with 15 AMP (TR) GFI receptacle
PUFP-SC ①	6" Stainless Steel pop up floor plate with 6 port Comm./Data device (max 3 CAT6 jacks)
PUFP-SD ①	6" Stainless Steel pop up floor plate with 15 AMP (TR) decora receptacle

① Requires PUFP-LRA to mount to FB box

UL recognized components: PUFP series UL recognized 498, ETL listed P63; TCP series marked cULus are UL listed 498



TCP-1: 5 3/4" flanged cover, with 2" - 1/2" combo plug for Comm./Data. or single receptacle
OPTIONS: -3/4" for 2" - 3/4" combo plug for Comm./Data. or single receptacle
 -1" for 2" - 1" combo plug for Comm./Data. or single receptacle



Finish Options

- Brass » TCP-1 cULus
- Brass » TCP-1-3/4"
- Brass » TCP-1-1"
- Nickel Silver » TCP-1-NS

TCP-1-PC: 5 3/4" Brass flanged cover, with 2" - 1/2" combo plug for Comm./Data. or single recept., & (2) 1/2" plugs for Comm./Data



Finish Options

- Brass » TCP-1-PC cULus

TCP-2-PC: 5 3/4" flanged cover, with (2) 1 1/2" screw plugs for duplex power or Comm./Data., & (2) 1/2" plugs for Comm./Data



Finish Options

- Brass » TCP-2-PC cULus
- Aluminum » TCP-2-PC-A

TCP-2: 5 3/4" flanged cover, with (2) 1 1/2", screw plugs for duplex power or Comm./Data



Finish Options

- Brass » TCP-2 cULus
- Aluminum » TCP-2-A cULus
- Dark Bronze » TCP-2-DB
- Nickel Silver » TCP-2-NS

TCP-2-LR: 5 3/4" Seamless flanged cover, with dual flip lid and duplex mounting plate

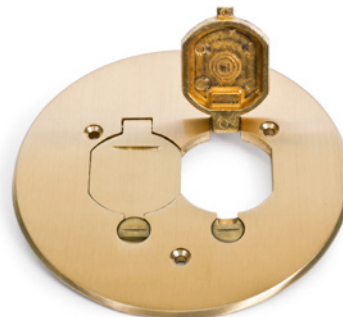

Finish Options

- Brass » TCP-2-LR cULus
- Aluminum » TCP-2-LR-A cULus
- Dark Bronze » TCP-2-LR-DB

RECESSED ACCESS NEW Floor boxes

*** Notes:**

- ① The Recessed/Access Floor Box Series all come with a combination blank/decora face plate only and do not contain devices.
- ② All boxes equipped with 4 leveling feet assemblies and a concrete cover for concrete floor application. For raised or wood floor applications, disregard.

DESCRIPTION						
Dual service floor box for use in a poured concrete floor, raised floor or wood floor						
CATALOG #	BASE BOX			COVER		
	W	L	D	W	L	H
TWO GANG: 2200 (Black Powder Coated cover) / 2200-S (Stainless cover)	8.5"	6"	2.75"	9.25"	9.25"	0.27"
FOUR GANG: 4200 (Black Powder Coated cover) / 4200-S (Stainless cover)	8.5"	10.75"	2.75"	9.25"	14"	0.27"
SIX GANG: 6200 (Black Powder Coated cover) / 6200-S (Stainless cover)	8.5"	10.75"	4.5"	9.25"	14"	0.27"
EIGHT GANG: 8200 (Black Powder Coated cover) / 8200-S (Stainless cover)	8.5"	10.75"	4.5"	9.25"	14"	0.27"
TWELVE GANG: 12200 (Black Powder Coated cover) / 12200-S (Stainless cover)	15"	15"	5"	16"	17.5"	0.27"

TWO GANG: 2200 (BLACK POWDER COATED COVER) / 2200-S (STAINLESS COVER)

KNOCKOUTS

POWER SIDE: 2X (1/2 - 3/4") NPS KOs on side
COMM/AV SIDE: 2X (1/2 - 3/4") NPS KOs on side & 2X (1 1/2") NPS KOs on bottom



FOUR GANG: 4200 (BLACK POWDER COATED COVER) / 4200-S (STAINLESS COVER)

KNOCKOUTS

POWER SIDE: 2X (1/2 - 3/4") NPS KOs on side
COMM/AV SIDE: 2X (1/2 - 3/4") NPS KOs on side & 2X (1 1/2") NPS KOs on bottom



SIX GANG: 6200 (BLACK POWDER COATED COVER) / 6200-S (STAINLESS COVER)

KNOCKOUTS

POWER SIDE: 2X (1/2 - 3/4") NPS KOs on side
COMM/AV SIDE: 2X (1 1/2 - 2") NPS KOs on side



RECESSED ACCESS **NEW** Floor boxes

*** Notes:**

- 1 The Recessed/Access Floor Box Series all come with a combination blank/decora face plate only and do not contain devices.
- 2 All boxes equipped with 4 leveling feet assemblies and a concrete cover for concrete floor application. For raised or wood floor applications, disregard.

EIGHT GANG: 8200 (BLACK POWDER COATED COVER) / 8200-S (STAINLESS COVER)



All Recessed Access floor boxes pp 38-39:

Conforms to UL 514A

LEW ELECTRIC FITTINGS CO.

Intertek
5023668

KNOCKOUTS

POWER SIDE: 2X (1/2 - 3/4") NPS KOs on side
COMM/AV SIDE: 2X (1 1/2 - 2") NPS KOs on side



TWELVE GANG: 12200 (BLACK POWDER COATED COVER) / 12200-S (STAINLESS COVER)

KNOCKOUTS

POWER SIDE: 2X (1/2 - 3/4") NPS KOs on side
COMM/AV SIDE: 2X (1 1/2 - 2") NPS KOs on side



1101 Rectangular Boxes—Covers & Flanges

CATALOG #	DESCRIPTION	LENGTH	WIDTH	HEIGHT	VOLUME
1101-SMB	One gang, deep stamped steel floor box	6 1/16"	4 13/16"	3 1/4"	50.3 Cu. In.
1102-SMB	Two gang, deep stamped steel floor box	9 3/16"	4 13/16"	3 13/16"	48.5 Cu. In. per gang
1103-SMB	Three gang, deep stamped steel floor box	12 3/8"	4 13/16"	3 1/4"	38.3 Cu. In. per gang
SH-1101-SMB	One gang, shallow stamped steel floor box	6 1/16"	4 13/16"	2 5/16"	31.5 Cu. In.
SH-1102-SMB	Two gang, shallow stamped steel floor box	9 3/16"	4 13/16"	2 5/16"	33.5 Cu. In. per gang
SH-1103-SMB	Three gang, shallow stamped steel floor box	12 3/8"	4 13/16"	2 11/16"	25.5 Cu. In. per gang
1101-DBE ① ②	One gang, tile frame	4 5/16"	3 11/32"	5/8"	XXXXX
1102-DBE ① ②	Two gang, tile frame	6 3/8"	4 3/8"	5/8"	XXXXX
1103-DBE ① ②	Three gang, tile frame	9 5/16"	4 5/16"	5/8"	XXXXX

① Add -A for Aluminum tile frame; ② Add -B for Brass tile frame

>>>> All boxes UL listing #514A

>>>> Tile frames not included with stamped steel floor box. All tile frames 5/8" overall height

>>>> All boxes pre-pour adjustment of 2 1/4" and after pour adjustment 1/2"

>>>> All boxes include a concrete cap

>>>> Knockouts: *Deep* – Sides and Bottom: 3/4", 1", 1 1/4"; *Shallow* – Sides: 1/2" and 3/4"; Bottom: 3/4", 1" and 1 1/4"

1101-SMB

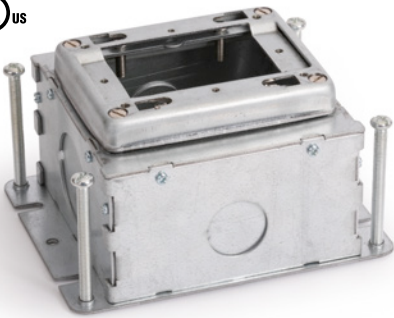

1102-SMB



■ Partitions not removable
■ Requires (2) 6304 Series covers, see p.41

1103-SMB



■ Partitions not removable
■ Requires (3) 6304 Series covers, see p.41

SH-1101-SMB



SH-1102-SMB



■ Partitions not removable
■ Requires (2) 6304 Series covers, see p.41

SH-1103-SMB



■ Partitions not removable
■ Requires (3) 6304 Series covers, see p.41

1101-DBE-B



1102-DBE-A

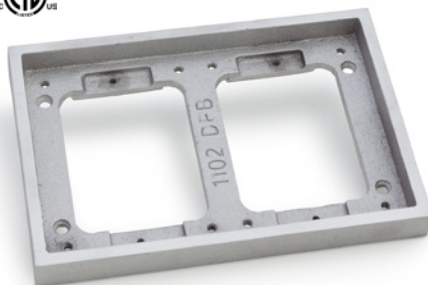

1103-DBE-B

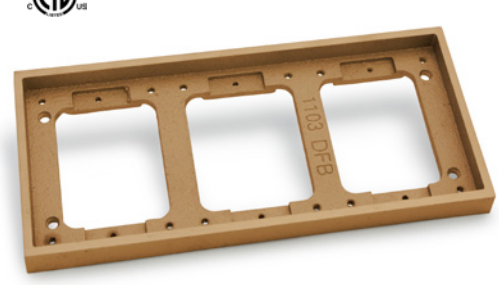

1101 Rectangular Boxes—Covers & Flanges

»»»» For Replacement Plugs, see page 49



6304-DFB-1

6304-DFB-1: Hinged 2 7/8" x 3 7/8" cover (1/4" thick) for duplex

OPTIONS: -TEL for Comm./Data
 -GFI for GFI or decora receptacle



Finish Options

 
 Brass » 6304-DFB-1
 Brass » 6304-DFB-1-TEL
 Brass » 6304-DFB-1-GFI

 
 Aluminum » 6304-DFB-1-A
 Aluminum » 6304-DFB-1-TEL-A
 Aluminum » 6304-DFB-1-GFI-A

6304-DFB-LR

6304-DFB-LR: Dual hinged 2 7/8" x 3 7/8" cover (1/4" thick) for duplex

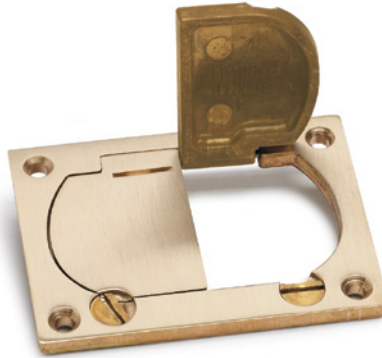

Finish Options

 
 Brass » 6304-DFB-LR

 Aluminum » 6304-DFB-LR-A

6304-DP

6304-DP: 2 7/8" x 3 7/8" cover (1/8" thick) with (2) 1 1/2" screw plugs for duplex



Finish Options

 
 Brass » 6304-DP



 Aluminum » 6304-DP-A

6304-S

6304-S: 2 7/8" x 3 7/8" cover (1/8" thick) with 2"–1/2" combo plug for Comm./Data

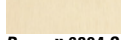

Finish Options

 
 Brass » 6304-S



 Aluminum » 6304-S-A

6304-S-3/4

6304-S-3/4: Brass, 2 7/8" x 3 7/8" cover (1/8" thick) with 2"–3/4" combo plug for Comm./Data



Finish Options



 Brass » 6304-S-3/4

6304-S-1

6304-S-1: Brass, 2 7/8" x 3 7/8" cover (1/8" thick) with 2"–1" combo plug for Comm./Data

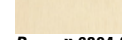

Finish Options

 Brass » 6304-S-1

CF-1101-DFB

CF-1101-DFB: Single gang carpet flange, 5 1/32" x 6 1/4"



Finish Options

 Brass » CF-1101-DFB

 Aluminum » CF-1101-DFB-A

CF-1102-DFB

CF-1102-DFB: Two gang carpet flange, 6 1/4" x 8 1/4"



Finish Options

 Brass » CF-1102-DFB

 Aluminum » CF-1102-DFB-A

CF-1103-DFB

CF-1103-DFB: Three gang Brass carpet flange, 6 1/4" x 11 1/8"



Finish Options

 Brass » CF-1103-DFB

 Aluminum » CF-1103-DFB-A

1101 Rectangular Boxes—Fully Adjustable

CATALOG #	DESCRIPTION	DIMENSIONS			ADJUST AFTER	INTERIOR CAPACITY	CONDUIT OPENINGS	MAX TAP
		H	L	W				
1101-58 ①	Deep, single gang cast box, Fully adjustable	3 3/4"	4 1/4"	3 3/8"	3/8"	13 Cu. In. (Min)	Sides (4) 3/4"	1 1/4"
1102-58 ①	Deep, two gang cast box (partitioned—removable), Fully adjustable	3 3/4"	6 3/8"	4 3/8"	3/8"	26 Cu. In. (Min) (13 Cu. In./Gang)	Sides (6) 3/4"	1 1/4"
1103-58 ①	Deep, three gang cast box (partitioned—removable), Fully adjustable	3 3/4"	9 1/4"	4 5/16"	3/8"	40 Cu. In. (Min) (13 Cu. In./Gang)	Sides (8) 3/4"	1 1/4"

① Add -A for Aluminum finish

>>>> All boxes UL listing #514A, #498, and include a concrete cap

1101-58



1102-58-A

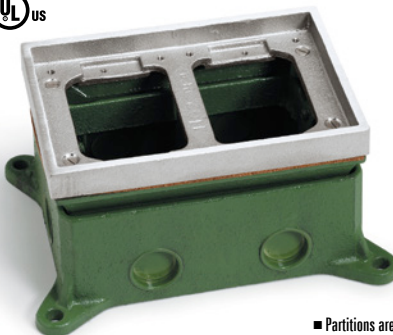

■ Partitions are removable
■ Requires (2) 6304 Series covers, see p.43

1103-58

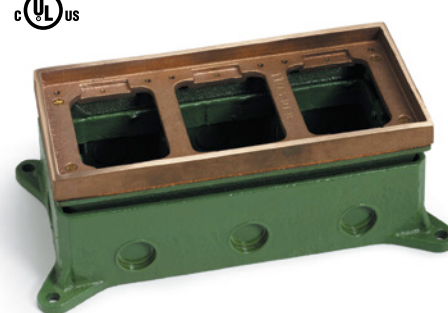

■ Partitions are removable
■ Requires (3) 6304 Series covers, see p.43

1101 Rectangular Boxes—Semi Adjustable

CATALOG #	DESCRIPTION	DIMENSIONS			ADJUST BEFORE	INTERIOR CAPACITY	CONDUIT OPENINGS	MAX TAP
		H	L	W				
SH-1101-DA	Shallow, single gang die cast aluminum box, Semi adjustable (*DOES NOT INCLUDE TILE FRAME)	2 1/4"	4 1/4"	3 3/8"	1 3/16"	15.5 Cu. In.	Sides (4) 3/4"	3/4"
SH-6262-58 ①	Shallow, two gang cast box (partitioned—removable), Semi adjustable	2 1/4"	6 3/8"	4 3/8"	1"	25 Cu. In. (12.5 Cu. In./Gang)	Sides (6) 3/4"	1"
SH-6263-58 ①	Shallow, three gang cast box (partitioned—removable), Semi adjustable	2 1/4"	9 1/4"	4 5/16"	1"	50 Cu. In. (16.5 Cu. In./Gang)	Sides (8) 3/4"	1"

① Add -A for Aluminum finish

>>>> All boxes include a concrete cap

SH-1101-DA



■ Requires 1101-DBE tile frame, see p.40

SH-6262-58-A

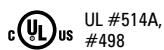

■ Partitions are removable
■ Requires (2) 6304 Series covers, see p.43

SH-6263-58



■ Partitions are removable
■ Requires (3) 6304 Series covers, see p.43

1101 Rectangular Boxes—Covers & Flanges

>>>> For Replacement Plugs, see page 49

6304-DFB-1

6304-DFB-1: Hinged 2 7/8" x 3 7/8" cover (1/4" thick) for duplex

OPTIONS: -TEL for Comm./Data
 -GFI for GFI or Decora receptacle



Finish Options

 cUL US
 Brass » 6304-DFB-1
 Brass » 6304-DFB-1-TEL
 Brass » 6304-DFB-1-GFI

 cUL US
 Aluminum » 6304-DFB-1-A
 Aluminum » 6304-DFB-1-TEL-A
 Aluminum » 6304-DFB-1-GFI-A

6304-DFB-LR

6304-DFB-LR: Dual hinged 2 7/8" x 3 7/8" cover (1/4" thick) for duplex

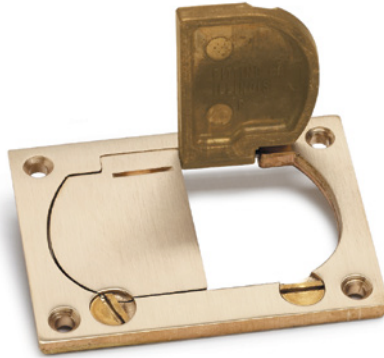

Finish Options

 cUL US
 Brass » 6304-DFB-LR



 Aluminum » 6304-DFB-LR-A

6304-DP

6304-DP: 2 7/8" x 3 7/8" cover (1/8" thick) with (2) 1 1/2" screw plugs for duplex



Finish Options

 cUL US
 Brass » 6304-DP



 Aluminum » 6304-DP-A

6304-S

6304-S: 2 7/8" x 3 7/8" cover (1/8" thick) with 2"–1/2" combo plug for Comm./Data

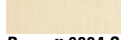

Finish Options

 cUL US
 Brass » 6304-S

 Aluminum » 6304-S-A

6304-S-3/4

6304-S-3/4: Brass, 2 7/8" x 3 7/8" cover (1/8" thick) with 2"–3/4" combo plug for Comm./Data



Finish Options



 Brass » 6304-S-3/4

6304-S-1

6304-S-1: Brass, 2 7/8" x 3 7/8" cover (1/8" thick) with 2"–1" combo plug for Comm./Data

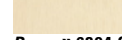

Finish Options

 Brass » 6304-S-1

CF-1101-DFB

CF-1101-DFB: Single gang carpet flange, 5 1/32" x 6 1/4"



Finish Options

 Brass » CF-1101-DFB

 Aluminum » CF-1101-DFB-A

CF-1102-DFB

CF-1102-DFB: Two gang carpet flange, 6 1/4" x 8 1/4"



Finish Options

 Brass » CF-1102-DFB

 Aluminum » CF-1102-DFB-A

CF-1103-DFB

CF-1103-DFB: Three gang Brass carpet flange, 6 1/4" x 11 1/8"



Finish Options

 Brass » CF-1103-DFB

 Aluminum » CF-1103-DFB-A

32 Round Boxes, Adjustable

CATALOG #	DESCRIPTION	DIMENSIONS		ADJUST BEFORE	ADJUST AFTER	INTERIOR CAPACITY	CONDUIT OPENINGS	MAX TAP
		A	B					
532-DA ①	Deep, die cast aluminum box, <i>Fully adjustable</i>	4 1/4"	4 3/32"	X	9/16"	32 Cu. In.	Sides (4) 3/4"	1"
532-SMB	Deep Stamped Steel, <i>Fully adjustable</i>	4 11/16"	3 3/4"	2 1/4"	1/2"	57 Cu. In.	1/2", 3/4", 1", 1 1/4"	none
532-SMB-SB ③	Shallow, Stamped Steel, <i>Fully adjustable</i>	4 11/16"	2 13/16"	2 1/4"	1/2"	43.8 Cu. In.	Sides (6) 1/2", (4) 3/4" Bottom (3) 1/2", (2) 3/4"	none
CATALOG #	DESCRIPTION	DIMENSIONS		ADJUST BEFORE	ADJUST AFTER	INTERIOR CAPACITY	CONDUIT OPENINGS	MAX TAP
A	B							
332-DA ①	Shallow, die cast aluminum box, <i>Semi adjustable</i>	4 1/4"	2 3/16"	1"	X	13 Cu. In.	Sides (4) 3/4"	3/4"

① Add -A for Aluminum finish; ② additional 3/4" conduit opening in bottom of box;

③ additional 3/4" (2) & 1/2" (2) conduit openings in bottom

>>>> All boxes: Single service only (power or data)

532-DA

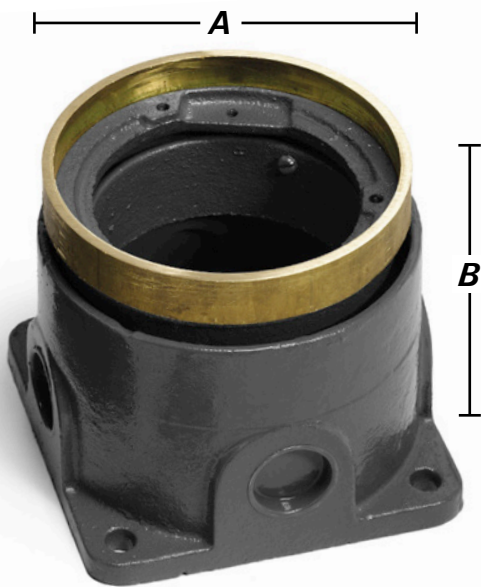

ETL
Brass only:
Conforms to
UL #514A,
CSA 22.2#18
ETL 4004534

532-SMB

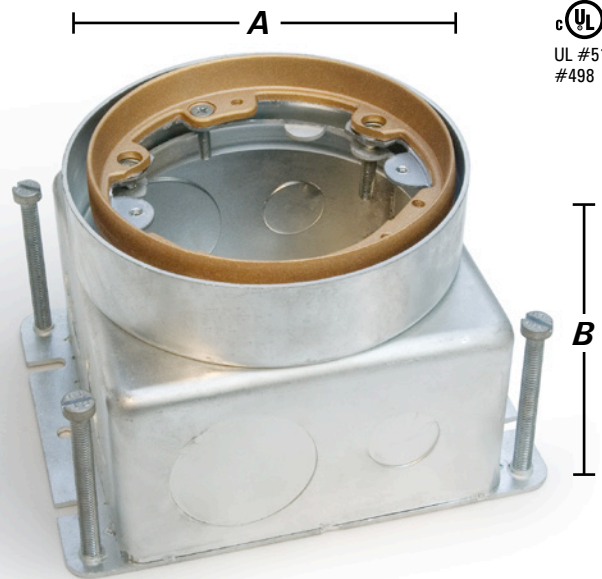

US
UL #514A,
#498

532-SMB-SB

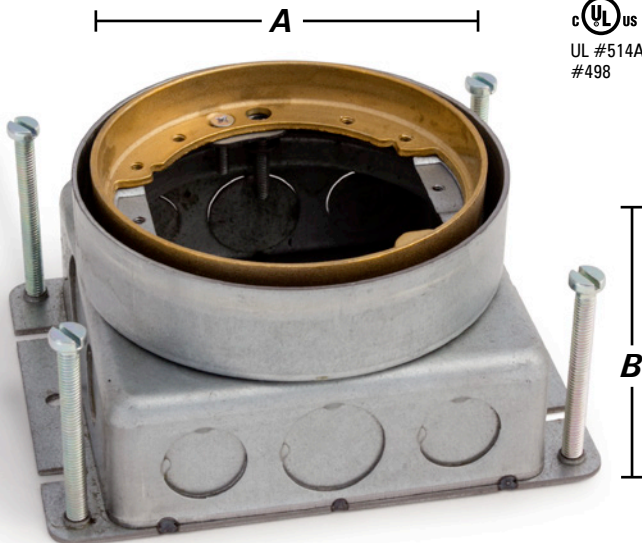

US
UL #514A,
#498

332-DA

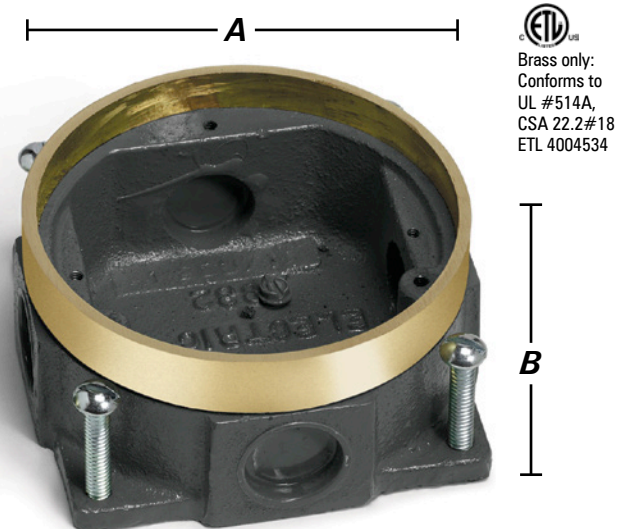

ETL
Brass only:
Conforms to
UL #514A,
CSA 22.2#18
ETL 4004534

32 Round Box Covers

>>>> For Replacement Plugs, see page 49

523-DP

523-DP: 4" cover (1/8" thick) with (2) 1 1/2" screw plugs for duplex



Finish Options

  Brass » 523-DP	  Aluminum » 523-DP-A
 Dark Bronze » 523-DP-DB	  Nickel Silver » 523-DP-NS

524

524: 4" cover (1/8" thick) with 2" - 1/2" combo plug for Comm./Data



Finish Options

  Brass » 524
--

DFB-LR

DFB-LR: 4" dual hinged cover (1/4" thick) for duplex

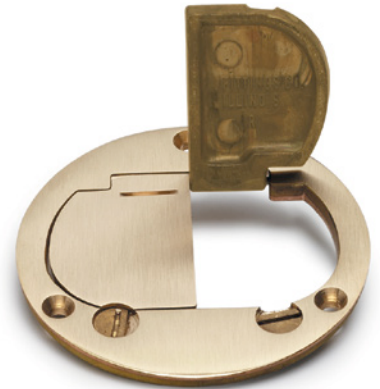

Finish Options

  Brass » DFB-LR	 Aluminum » DFB-LR-A	 Dark Bronze » DFB-LR-DB
---	--	--

DFB-1

DFB-1: 4" hinged cover (1/4" thick) for duplex



Finish Options





  Brass » DFB-1	 Aluminum » DFB-1-A	 Dark Bronze » DFB-1-DB
---	---	---

SCF-1

SCF-1: 5 1/4" flange

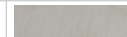

Finish Options

 Brass » SCF-1	 Aluminum » SCF-1-A	 Dark Bronze » SCF-1-DB
 Clear Plastic » SCF-1-CP	 Nickel Silver » SCF-1-NS	

TCP-1

TCP-1: 5 3/4" flanged cover, with 2" - 1/2" combo plug for Comm./Data. or single receptacle



Finish Options







  Brass » TCP-1	 Nickel Silver » TCP-1-NS
--	---

TCP-2

TCP-2: 5 3/4" flanged cover, with (2) 1 1/2" screw plugs for duplex power or Comm./Data



Finish Options





  Brass » TCP-2	  Aluminum » TCP-2-A
 Dark Bronze » TCP-2-DB	 Nickel Silver » TCP-2-NS

TCP-2-LR

TCP-2-LR: 5 3/4" Seamless flanged cover, with dual flip lid and duplex mounting plate



Finish Options

  Brass » TCP-2-LR	  Aluminum » TCP-2-LR-A
 Dark Bronze » TCP-2-LR-DB	

All covers page 45: ETL listed 4004534,
 UL listed 514D, CSA 22.2#42, Marked  UL listed 498

IN-SLAB: MOI-SLB & MOI-SLB-REC

FEATURES & BENEFITS

- **Totally enclosed and partitioned compartments** for Power/Voice/Data in one unit
- **4 to 10 jacks** for Voice and Data in one unit
- **Completely flush** with 1/4" carpet or other flooring
- Finish available in **Stainless Steel, Brass or Black**
- Slab Unit can be **poured into slab** for Slab-On-Grade construction
- Recessed configuration allows for **cover to be closed while in use (MOI-SLB-REC only)**



Conforms to UL 514A
LEW ELECTRIC
FITTINGS CO.

MOI-SLB

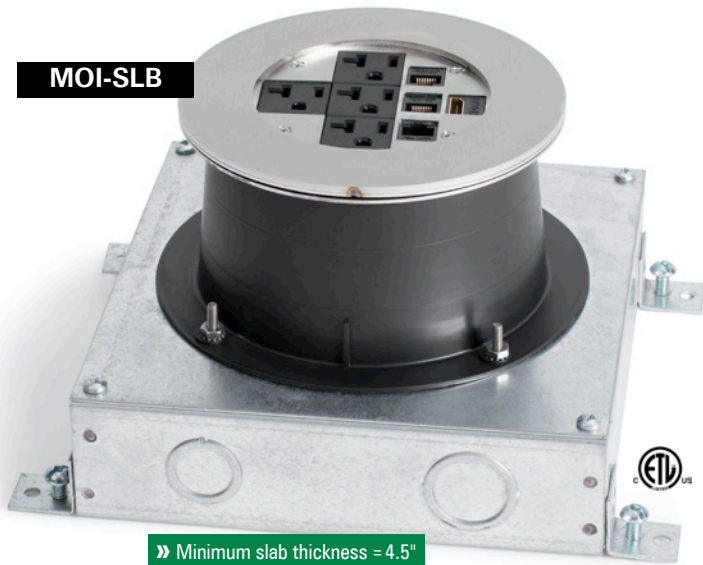

» Minimum slab thickness = 4.5"

MOI-SLB-REC » one cover option only:

Articulated Hinged Cover – Cable Exit Door (AHC-CED)

- » Outer ring diameter = 6"
- » Inner ring diameter = 3.985"
- » Color options:
 - Stainless Steel
 - Brass
 - Black

MOI-SLB-REC



» Minimum slab thickness = 7.1"

COVER OPTIONS (MOI-SLB)

Articulated Hinged Cover

Articulated Hinged Cover 1/4 Turn

» Outer ring diameter = 6"
» Inner ring diameter = 3.985"

Threaded Security
(Brass shown)

» Outer ring diameter = 6"
» Inner ring diameter = 3 9/16"

Threaded Coin
(Stainless Steel shown)

Drop Cover
(Black shown)

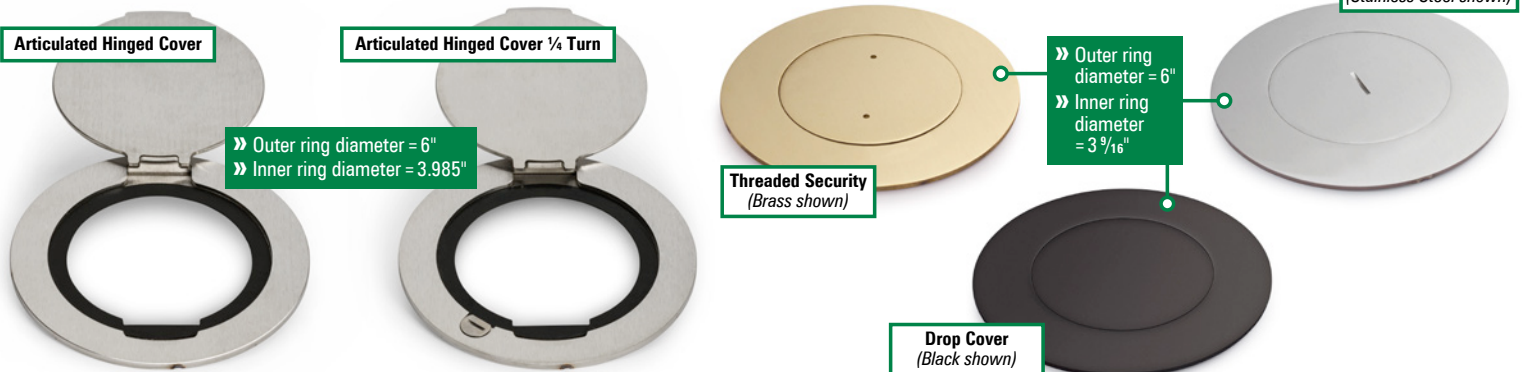

HOW TO ORDER

STEP 1 » Choose **MOI-SLB** or **MOI-SLB-REC** (Recessed In-Slab)



STEP 2 » Choose Configuration * (20amp standard, 15amp available)

*Configuration does not include communication components

	COMM10 » Ten communication openings
	DP1 » Decora receptacle
	DP1-COMM4 » Decora receptacle & (4) communication openings
	PASS-THROUGH » 2.5" trade size circular opening
	PWR2-COMM4 » (2) single receptacle & (4) communication openings
	PWR2-COMM4-DB15 » (2) single receptacle & (4) communication openings & (1) DB-15 opening

	PWR2-COMM5 » (2) single receptacle & (5) communication openings
	PWR2-COMM6 » (2) single receptacle & (6) communication openings
	PWR4 » (4) single receptacle
	PWR4-COMM4 » (4) single receptacle & (4) communication openings
	SYS-COMM » Systems furniture communication-power & comm cabling
	AV-COMM4 » (1) Decora opening for CI-5BWPA & (4) communication openings

EXAMPLE: MOI-SLB-PWR4-COMM4

STEP 3 » Choose Cover Finish

Stainless Steel
 Add: **-SS**

MOI-SLB Cover Types:

- Drop Cover
- Threaded Coin
- Threaded Security
- Articulated Hinged Cover
- Articulated Hinged Cover ¼ Turn

MOI-SLB-REC Cover Types:

- Articulated Hinged Cover-Cable Exit Door

Brass
 Add: **-BR**

MOI-SLB Cover Types:

- Drop Cover
- Threaded Coin
- Threaded Security
- Articulated Hinged Cover
- Articulated Hinged Cover ¼ Turn

MOI-SLB-REC Cover Types:

- Articulated Hinged Cover-Cable Exit Door

Black
 Add: **-BK**

MOI-SLB Cover Types:

- Drop Cover
- Articulated Hinged Cover
- Articulated Hinged Cover ¼ Turn

MOI-SLB-REC Cover Types:

- Articulated Hinged Cover-Cable Exit Door

STEP 4 » Choose Cover Type for MOI-SLB (AHC-CED Cover only for MOI-SLB-REC)

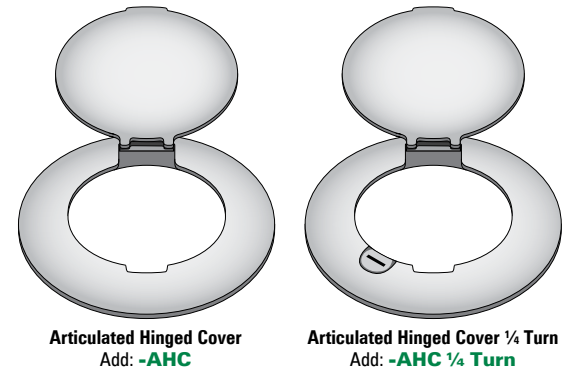
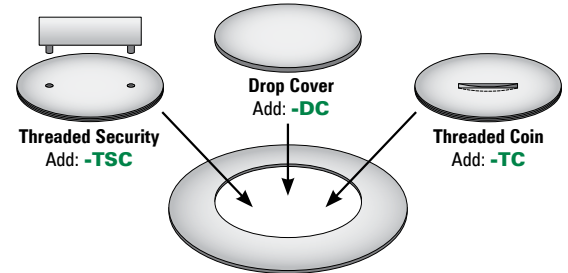

EXAMPLE

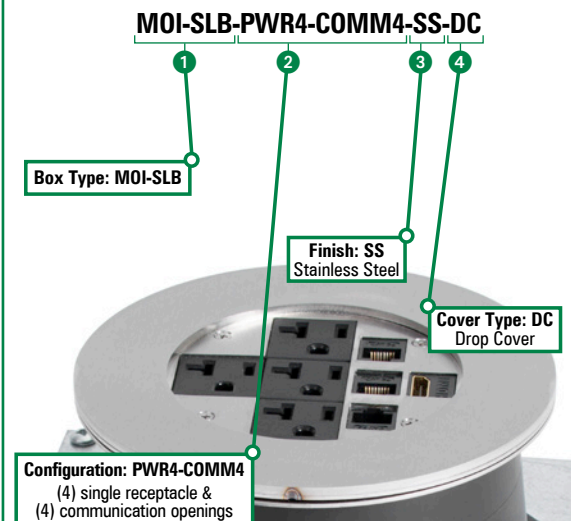

NOZZLES *FDN-250-A*

CATALOG #	DESCRIPTION	DIMENSIONS			STANDARD OPENINGS
		H	L	D	
FDN-250-A	Aluminum floor nozzle (Sand Casted Aluminum)	2 7/8"	4"	2 7/8"	3/4" (Also available in 1/2" or 1", please specify)
203-A ①	Blank nozzle plate				
204-A ①	Nozzle plate for duplex receptacle				
206-A ①	Nozzle plate for single receptacle or cable				
207-A ①	Nozzle plate for GFI receptacle				

① Each Floor Nozzle requires two plates.

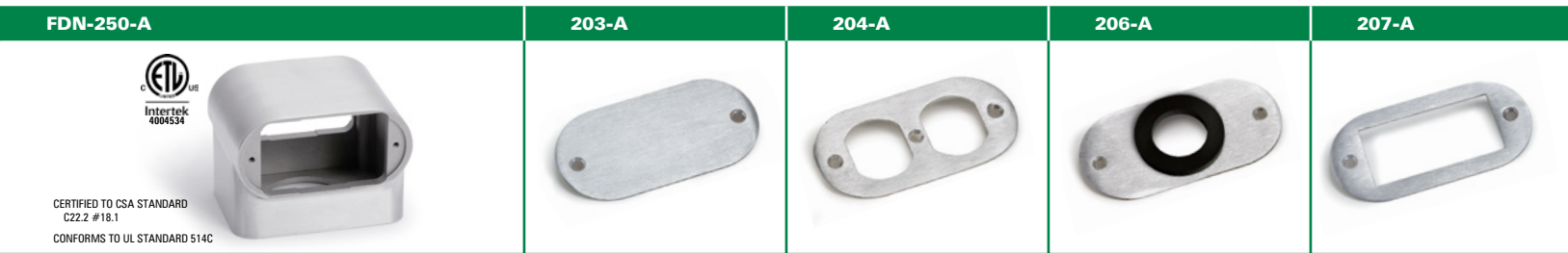

FDN-200-A

CATALOG #	DESCRIPTION	DIMENSIONS			STANDARD OPENINGS
		H	L	D	
FDN-200-A	Aluminum floor nozzle with partition (Die Cast Aluminum)	3"	4 3/4"	4 1/4"	(2) 3/4" (Threaded)
203-A ①	Blank nozzle plate				
204-A ①	Nozzle plate for duplex receptacle				
206-A ①	Nozzle plate for single receptacle or cable				
207-A ①	Nozzle plate for GFI receptacle				

① Each Floor Nozzle requires two plates.

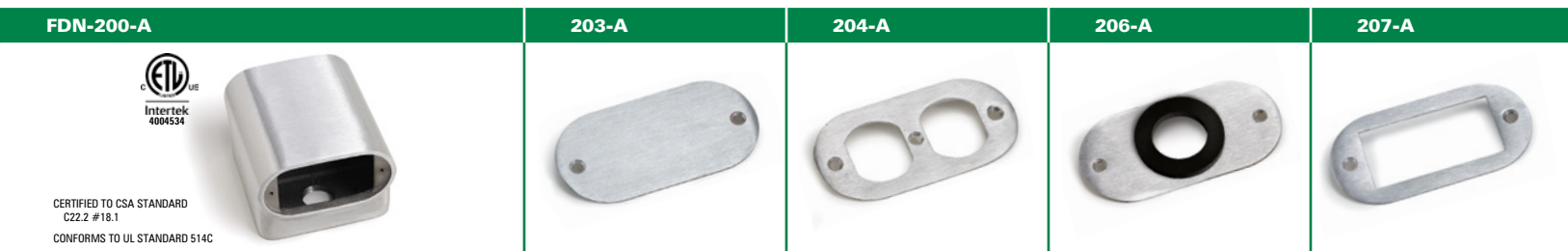

FDN-100-A

CATALOG #	DESCRIPTION	DIMENSIONS			STANDARD OPENINGS
		H	L	D	
FDN-100-A	Aluminum floor nozzle (Die Cast Aluminum) for up to (4) duplex receptacles (not included)	4 3/4"	4 1/4"	4 1/4"	1"
110-A ①	Nozzle plate will accommodate (2) duplex receptacles				
112-A ①	Blank nozzle plate (<i>Note: can be drilled out to specifications in the field</i>)				
113-A ①	Nozzle plate will accommodate (2) GFI receptacles				

① Each Floor Nozzle requires two plates.



Replacement Plugs

Product photos not to scale

6410-1/2

6410-1/2: 2"-1/2" combination plug

FITS COVERS:
 6304-S
 524
 TCP-1



Finish Options

Brass » 6410-1/2 Aluminum » 6410-1/2-A

6410-3/4

6410-3/4: Brass 2"-3/4" combination plug

FITS COVERS:
 6304-S-3/4"
 524-3/4



Finish Options

Brass » 6410-3/4

6410-1

6410-1: Brass 2"-1" combination plug

FITS COVERS:
 6304-S-1"
 524-1"



Finish Options

Brass » 6410-1

6208

6208: 1/2" close up plug

FITS COVERS:
 6304-S
 524
 TCP-1



Finish Options

Brass » 6208 Aluminum » 6208-A

6210

6210: 3/4" close up plug

FITS COVERS:
 6304-S-3/4"
 524-3/4



Finish Options

Brass » 6210

6211

6211: 1" close up plug

FITS COVERS:
 6304-S-1"
 524-1"



Finish Options

Brass » 6211

6212

6212: 1 1/4" close up plug

FITS COVERS:
 RRP/SWB-2 or -4



Finish Options

Brass » 6212 Aluminum » 6212-A
 Dark Bronze » 6212-DB Nickel Silver » 6212-NS

6213

6213: 1 1/2" close up plug (duplex covers)

FITS COVERS:
 523-DP (812)
 6304-DP (1101)
 TCP-2



Finish Options

Brass » 6213 Aluminum » 6213-A
 Dark Bronze » 6213-DB Nickel Silver » 6213-NS

6213-BP

6213-BP: Plated 1 1/2" close up plug (for RRP-1-BP & SWB-1-BP **ONLY**)

FITS COVERS:
 RRP-1-BP
 SWB-1-BP



Finish Options

Brass Plated » 6213-BP Nickel Plated » 6213-NP
 Dark Bronze Plated » 6213-DBP

6214

6214: 1 1/4" plug for RCFB series

FITS COVERS:
 RCFB-1
 RCFB-2



Finish Options

Brass » 6214 Aluminum » 6214-A
 Dark Bronze » 6214-DB

6215

6215: 1 1/2" close up plug

FITS COVERS:
 PBR-SPB
 RRP-2-SPB
 RRP-4-SPB
 RRP-6-SPB



Finish Options

Brass » 6215 Aluminum » 6215-A
 Dark Bronze » 6215-DB

**LEW ELECTRIC
 FITTINGS COMPANY**

1626 Tobacco Rd.
 Augusta, GA 30906

Ph: 877-537-2019

www.lewelectric.com

POKE-THROUGH: MOI4 & MOI4-REC

FEATURES & BENEFITS

- **Totally enclosed and partitioned compartments** for Power / Voice / Data in one unit
- **4 to 10 jacks** for Voice and Data in one unit
- **Threaded conduit openings** reduce the risk of tampering (or need for access to connections) in ceiling space below
- **Completely flush** with 1/4" carpet or other flooring
- Finish available in **Stainless Steel, Brass or Black**
- **4-inch core drill**
- Can be **installed through floor before or after carpet installation**



2-hour fire rating
Conforms to UL 514A
LEW ELECTRIC
FITTINGS CO.

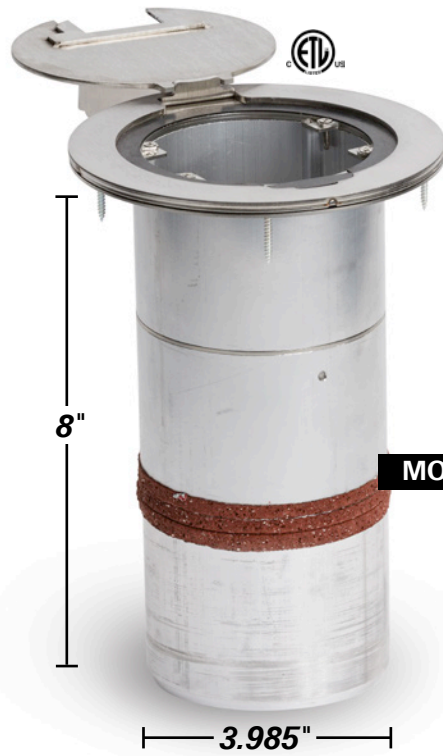
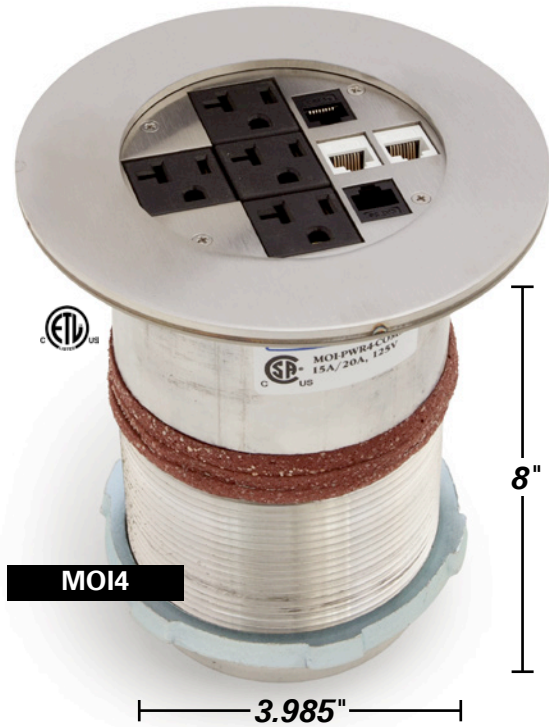

MOI4-REC » one cover option only:

Articulated Hinged Cover – Cable Exit Door (AHC-CED)

- » Outer ring diameter = 6"
- » Inner ring diameter = 3.985"
- » Color options: ■ Stainless Steel ■ Brass ■ Black



COVER OPTIONS (MOI4)



Articulated Hinged Cover

Articulated Hinged Cover 1/4 Turn

- » Outer ring diameter = 6"
- » Inner ring diameter = 3.985"

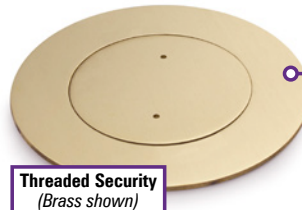

Threaded Security
(Brass shown)

- » Outer ring diameter = 6"
- » Inner ring diameter = 3 9/16"

Threaded Coin
(Stainless Steel shown)



Drop Cover
(Black shown)



HOW TO ORDER

STEP 1 » Choose MOI4 or MOI4-REC (Recessed MOI4)



STEP 2 » Choose Configuration* (20amp standard, 15amp available)

*Configuration does not include communication components

	COMM10 » Ten communication openings		PWR2-COMM5 » (2) single receptacle & (5) communication openings
	DP1 » Decora receptacle		PWR2-COMM6 » (2) single receptacle & (6) communication openings
	DP1-COMM4 » Decora receptacle & (4) communication openings		PWR4 » (4) single receptacle
	PASS-THROUGH » 2.5" trade size circular opening		PWR4-COMM4 » (4) single receptacle & (4) communication openings
	PWR2-COMM4 » (2) single receptacle & (4) communication openings		SYS-COMM » Systems furniture communication-power & comm cabling
	PWR2-COMM4-DB15 » (2) single receptacle & (4) communication openings & (1) DB-15 opening		AV-COMM4 » (1) Decora opening for CI-5BWPA & (4) communication openings

EXAMPLE: MOI4-PWR4-COMM4

STEP 3 » Choose Cover Finish

	Stainless Steel Add: -SS		Brass Add: -BR		Black Add: -BK
MOI4 Cover Types: Drop Cover Threaded Coin Threaded Security Articulated Hinged Cover Articulated Hinged Cover ¼ Turn MOI4-REC Cover Types: Articulated Hinged Cover-Cable Exit Door		MOI4 Cover Types: Drop Cover Threaded Coin Threaded Security Articulated Hinged Cover Articulated Hinged Cover ¼ Turn MOI4-REC Cover Types: Articulated Hinged Cover-Cable Exit Door		MOI4 Cover Types: Drop Cover Articulated Hinged Cover Articulated Hinged Cover ¼ Turn MOI4-REC Cover Types: Articulated Hinged Cover-Cable Exit Door	

STEP 4 » Choose Cover Type for MOI4 (AHC-CED Cover only for MOI4-REC)

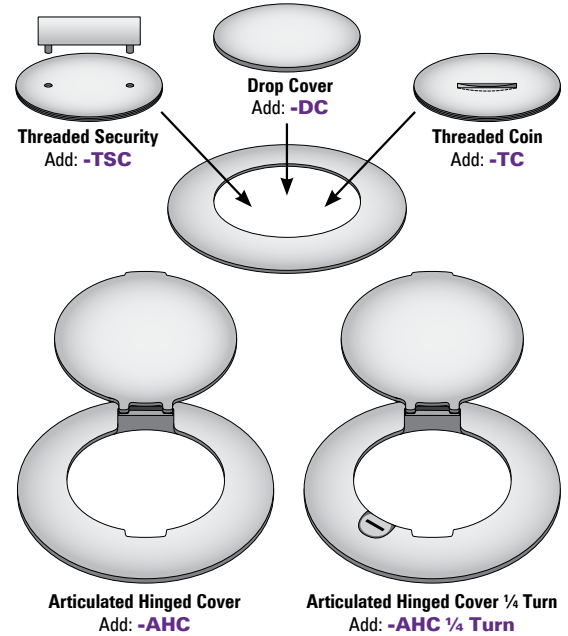

STEP 5 » Specify Slab Thickness

» Minimum slab thickness: MOI 4 inches, MOI-REC 6 inches.

** Standard and MINIMUM length is 8 inches. Larger custom lengths available.

EXAMPLE

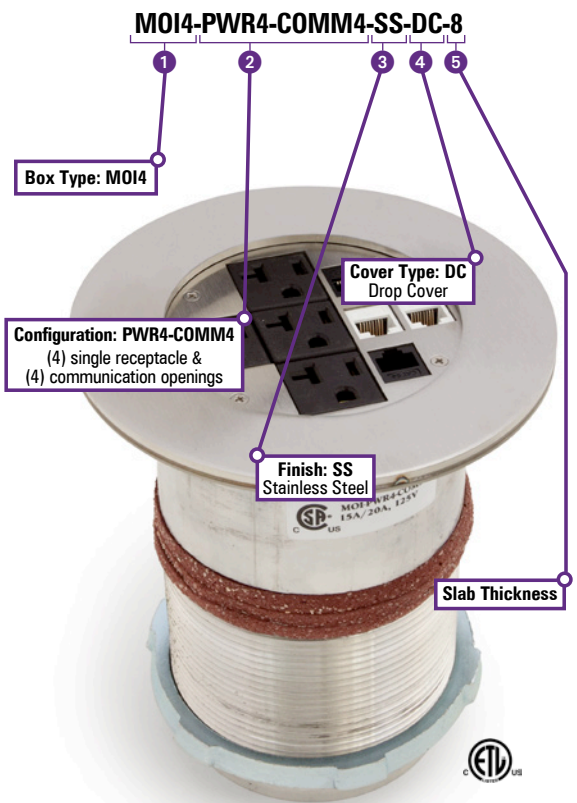

POKE-THROUGH: MOI6-REC **NEW**

FEATURES & BENEFITS

- **Totally enclosed and partitioned compartments** for Power / Voice / Data in one unit
- **4 outlets and 10 jacks** in one unit
- **Threaded conduit openings** reduce the risk of tampering (or need for access to connections) in ceiling space below
- **Completely flush** with 1/4" carpet or other flooring
- **6-inch core drill**
- Can be **installed through floor before or after carpet installation**
- Recessed configuration allows for **cover to be closed while in use**



2-hour fire rating
Conforms to UL 514A
LEW ELECTRIC
FITTINGS CO.



MOI6-REC



COVER

Articulated Hinged Cover – Cable Exit Door (AHC-CED)

- » Outer ring diameter = 8.35"
- » Inner ring diameter = 5.55"
- » Color options: ■ Stainless Steel
■ Brass
■ Black

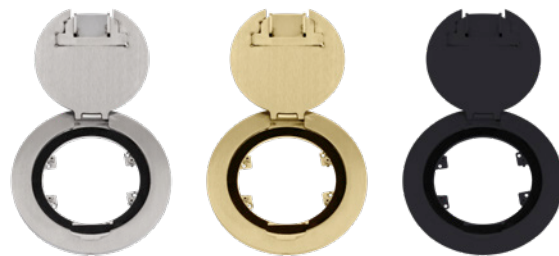

HOW TO ORDER

STEP 1 » MOI6-REC



MOI6-REC

STEP 2 » Choose Configuration * (20amp standard, 15amp available)

*Configuration does not include communication components

	DP-C8 » USB receptacle & (8) communication openings		P2-AV2 » (2) Power & (2) 6-port AV
	DPUSB(AC)-C8 » (1) 2USB (AC) receptacle & (8) communication openings		P4-AV-C2 » (4) Power & (1) 6-port AV & (2) communication openings
	DP2 » (2) Decora receptacle		P4-C4-AV1.5 » (4) Power & (4) communication openings & 1.5 inch AV opening
	DP-DPUSB(AC) » (1) Decora receptacle & (1) 2USB (AC) receptacle		P4-C8 » (4) Power & (8) communication openings
	DPUSB(AC)2 » (2) 2USB (AC) receptacles		P4-DP » (4) Power & (1) Decora receptacle
	P2-AV-C6 » (2) Power & (1) 6-port AV & (6) communication openings		P4-DPUSB(AC) » (4) Power & 2USB (AC) receptacle
	P2-DP-C6 » (2) Power & (1) Decora receptacle & (6) communication openings		P6-C4 » (6) Power & (4) communication openings
	P2-DPUSB(AC)-C6 » (2) Power & 2USB (AC) receptacle & (6) communication openings		

EXAMPLE: » MOI6-REC-P4-C8

STEP 3 » Choose Cover Finish (AHC-CED Cover only for MOI6-REC)

Stainless Steel
 Add: **-SS**

Brass
 Add: **-BR**

Black
 Add: **-BK**

EXAMPLE: » MOI6-REC-P4-C8-SS-AHC-CED

STEP 4 » Specify Slab Thickness

» Minimum slab thickness for MOI6 is 6 inches.

** Standard and MINIMUM length is 8 inches.
 Larger custom lengths available.

EXAMPLE



MOI6-REC-P4-C8-SS-AHC-CED-8

Box Type: MOI6-REC Recessed Poke-Through

Configuration: P4-C8

Cover Finish: SS-AHC-CED
 Stainless Steel Articulated Hinge Cover w/Cable Exit Door

Slab Thickness



POKE-THROUGH: MOI8-REC **NEW**

FEATURES & BENEFITS

- **Totally enclosed and partitioned compartments** for Power / Voice / Data in one unit
- **4 fully customizable compartments** for all Power/Data combination needs
- **Threaded conduit openings** reduce the risk of tampering (or need for access to connections) in ceiling space below
- **Completely flush** with 1/4" carpet or other flooring
- **8-inch core drill**
- Can be **installed through floor before or after carpet installation**
- Recessed configuration allows for **cover to be closed while in use**



COVER

Articulated Hinged Cover – Cable Exit Door (AHC-CED)

- » Outer ring diameter = 9.84"
- » Inner ring diameter = 7.99"
- » Color options: ■ Stainless Steel
■ Brass
■ Black

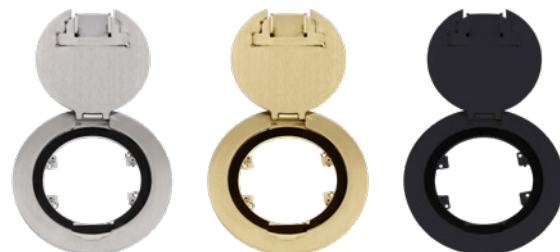

HOW TO ORDER

STEP 1 » MOI8-REC



MOI8-REC

STEP 2 » Choose Configuration * (20amp standard, 15amp available) Select 4 sections to complete the configuration

*Configuration does not include communication components

	2-inch NPS » 2-inch NPS opening		DB15 » (2) DB-15 openings
	3/4-inch NPS » 3/4-inch NPS opening		DP » Decora receptacle
	AV » 6-port AV		DPUSB » 2USB (AC) receptacle
	AVC2 » 6-port AV & (2) communication openings		MAAP » MAAP module opening
	Blank »		P4 » (4) single power
	C8 » (8) communication openings		P5 » (5) single power

EXAMPLE: » MOI8-REC-DP-DP-P5-C8

STEP 3 » Choose Cover Finish (AHC-CED Cover only for MOI8-REC)

Stainless Steel
 Add: **-SS**

Brass
 Add: **-BR**

Black
 Add: **-BK**

EXAMPLE: » MOI8-REC-DP-DP-P5-C8-SS-AHC-CED

STEP 4 » Specify Slab Thickness

» Minimum slab thickness for MOI8 is 6 inches.

** Standard and MINIMUM length is 8 inches.
 Larger custom lengths available.

EXAMPLE

MOI8-REC-DP-DP-P5-C8-SS-AHC-CED-8



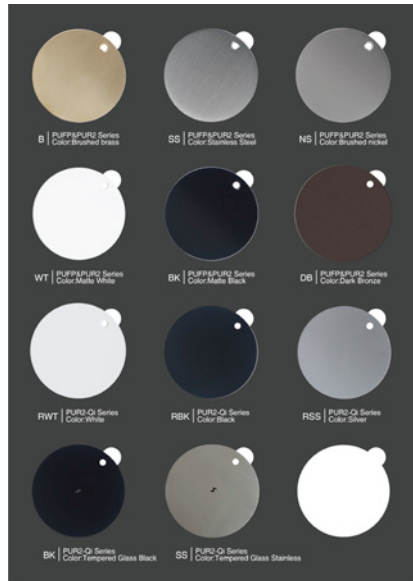

CATALOG #: **CT-CC**

*Color Chip Sample Book for
PUFP-CT (pp 14-17) and
PUR series (pp 3-11)*

Who We Are: We are the worldwide leader in providing safe and innovative floor boxes for residential and commercial use, providing floor boxes for homes, churches, airports and sports stadiums. We provide a solution for electrical needs where wall boxes are insufficient.

Guarantee: Located in Augusta, Georgia, **Low Electric Fittings Company** guarantees the fastest shipping and delivery in the market. We also provide full time experts at the factory to answer any questions regarding any floor box issue.

Mission Statement: Providing the power where power is needed!



LEW ELECTRIC FITTINGS COMPANY

1626 Tobacco Rd; Augusta, GA 30906

Ph: 877-537-2019

www.lewelectric.com